

TECHNICAL SPECIFICATION

COLOURS

WORKTOP



14 BEECH 26 ALUMINUM SATINATO 31 CANADIAN OAK 34 CHESTNUT 39 POLAR BIRCH



64 COCOA 67 WHITE PASTEL 106 LOWLAND NUT 154 ANTHRACITE

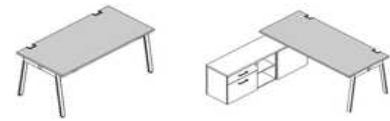

TOP



14 BEECH 26 ALUMINUM SATINATO 31 CANADIAN OAK 34 CHESTNUT 39 POLAR BIRCH



64 COCOA 67 WHITE PASTEL 106 LOWLAND NUT 154 ANTHRACITE

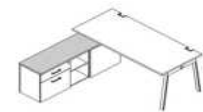

FRONT



14 BEECH 26 ALUMINUM SATINATO 31 CANADIAN OAK 34 CHESTNUT 39 POLAR BIRCH



64 COCOA 67 WHITE PASTEL 106 LOWLAND NUT 154 ANTHRACITE

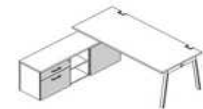

BODY, BOTTOM - FIRST GROUP



26 ALUMINUM SATINATO 67 WHITE PASTEL 154 ANTHRACITE

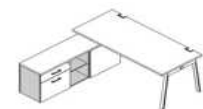

BODY, BOTTOM - SECOND GROUP



14 BEECH 31 CANADIAN OAK 34 CHESTNUT 39 POLAR BIRCH 64 COCOA



106 LOWLAND NUT

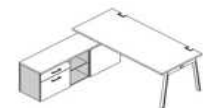

TECHNICAL SPECIFICATION

COLOURS

DRIVE - BENCH - FRAME

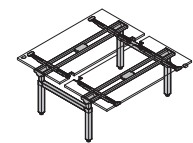
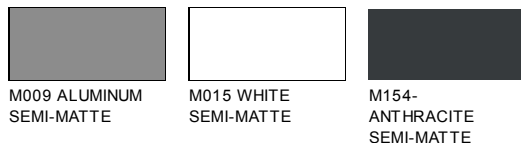

FRAME - YAN_Z, YAN_M, YAN_C

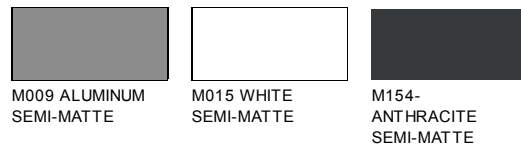

FRAME - YAN_T, DRIVE

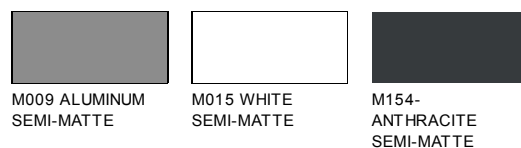

FOOT - YAN_T, DRIVE

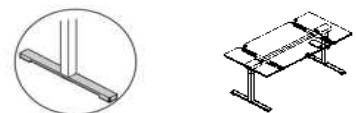
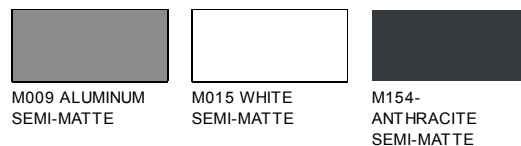

FOOT - YAN_T, DRIVE (FOOT EXTRA CHARGE 22,50€ PER FOOT (1PIECE) PER DESK 45€)

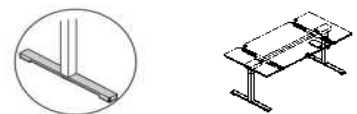

DESK EXTENSTIONS - WORKTOP - PL180, PLZ01, PLM01, PLC01



TECHNICAL SPECIFICATION

COLOURS

DESK EXTENSTIONS - FRAME - PL180, PLZ01



M009 ALUMINUM
SEMI-MATTE



M015 WHITE
SEMI-MATTE



M154-
ANTHRACITE
SEMI-MATTE



DESK ACCESSORIES - S120, S140, S160, S180



09 ALUMINUM

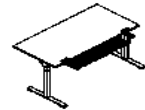

DESK ACCESSORIES - S87, S93



M009 ALUMINUM
SEMI-MATTE

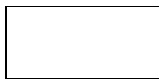

M015 WHITE
SEMI-MATTE



M154-
ANTHRACITE
SEMI-MATTE



GROMMET - BEIGE



14 BEECH



31 CANADIAN OAK



39 POLAR BIRCH



64 COCOA



GROMMET - WHITE

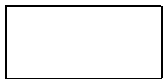

67 WHITE PASTEL



GROMMET - BROWN



34 CHESTNUT

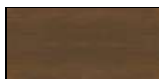

106 LOWLAND NUT



GROMMET - ANTHRACITE



154 ANTHRACITE



GROMMET - ALUMINUM



26 ALUMINUM
SATINATO



TECHNICAL SPECIFICATION

COLOURS

CABINETS - TOP, BOTTOM



CABINETS - FRONT



CABINETS - TAMBOUR

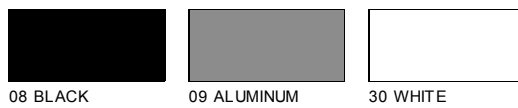

CABINETS - BODY - FIRST GROUP

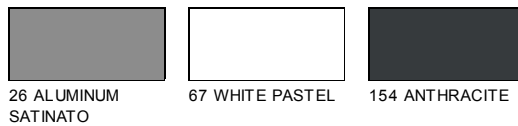

CABINETS - BODY - SECOND GROUP

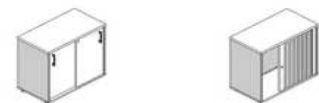

TECHNICAL SPECIFICATION

COLOURS

PEDESTALS - TOP



14 BEECH



26 ALUMINUM SATINATO



31 CANADIAN OAK



34 CHESTNUT



39 POLAR BIRCH



64 COCOA



67 WHITE PASTEL



106 LOWLAND NUT



154 ANTHRACITE



PEDESTALS - FRONT



14 BEECH



26 ALUMINUM SATINATO



31 CANADIAN OAK



34 CHESTNUT



39 POLAR BIRCH



64 COCOA

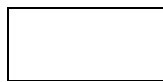

67 WHITE PASTEL



106 LOWLAND NUT



154 ANTHRACITE

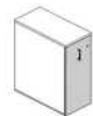

PEDESTALS - BODY - FIRST GROUP



26 ALUMINUM SATINATO

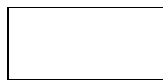

67 WHITE PASTEL



154 ANTHRACITE



PEDESTALS - BODY - SECOND GROUP



14 BEECH



31 CANADIAN OAK



34 CHESTNUT



39 POLAR BIRCH



64 COCOA













106 LOWLAND NUT



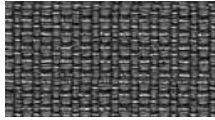







TECHNICAL SPECIFICATION

COLOURS



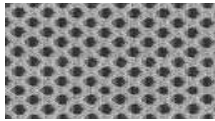





FABRIC PANEL - NEMO

 NE-1 BEIGE	 NE-2 YELLOW	 NE-3 ORANGE	 NE-5 RED	 NE-9 GREEN		
 NE-10 GREY	 NE-14 DARK GREY	 NE-15 NAVY BLUE	 NE-16 BLACK	 NE-17 BLUE		

FABRIC PANEL - RUNNER - SECOND GROUP

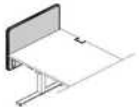
 R-63034 ORANGE	 R-64089 RED	 R-66063 BLUE	 R-60011 GREY	 R-68056 GREEN		
 R-66064 NAVY-BLUE	 R-60999 BLACK	 R-60025 DARK GREY	 R-61128 BEIGE			

FABRIC PANEL - MEDLEY - SECOND GROUP

 M-68005 DARK OLIVE	 M-68002 LIGHT OLIVE	 M-68115 GREEN	 M-61002 BEIGE	 M-67053 NAVY BLUE		
 M-67006 LIGHT BLUE	 M-66008 GREY	 M-64019 RED	 M-63064 PINK	 M-60999 BLACK		

FABRIC PANEL - ATLANTIC - SECOND GROUP

 A-67043 DARK TURQUOISE	 A-67030 SEA-GREEN	 A-60141 LIGHT GREY	 A-60011 GREY	 A-66064 NAVY BLUE		
 A-65037 VIOLET	 A-62048 OLIVE	 A-64089 RED	 A-61078 BEIGE	 A-60025 GRAPHITE		

TECHNICAL SPECIFICATION

COLOURS

FABRIC PANEL - SYNERGY - THIRD PRICE GROUP



LDS08 GREY
MELANGE



LDS20 LIGHT GREY



LDS27 BLACK



LDS29 DARK GREY



LDS50 DARK GREEN



LDS53 GREEN



LDS57 TURQUOISE

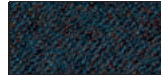

LDS60 BOTTLE
GREEN

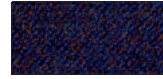

LDS61 PLUM



LDS69 NAVY BLUE



LDS84 ORANGE



LDS86 RED



LDS88 AUBERGINE



LDS85 CORAL

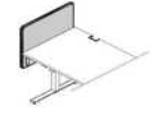

FABRIC PANEL - XTREME - THIRD PRICE GROUP



XR160 SEA-GREEN



XR430 DARK
TURQUOISE



XR026 NAVY BLUE



XR084 VIOLET



XR009 BLACK



XR420 OLIVE



XR081 DARK GREY



XR094 GREY



XR108 BEIGE



XR079 RED



YS158 BROWN



YS083
BLUE-GREY



YS071
LIGHT BROWN



YS166 SAND BROWN



TECHNICAL SPECIFICATION

WORKTOP

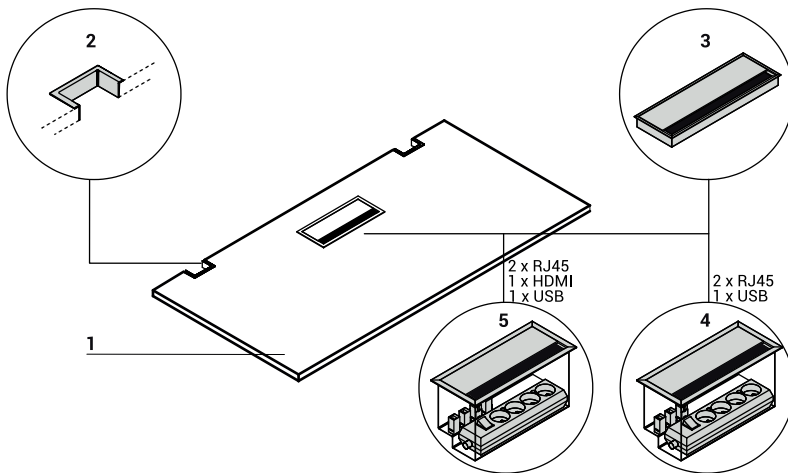

1. **Worktop** - MFC 28mm, PVC edge
2. **Rectangular grommet**- 90x48mm
3. **Option with additional charge** - Top access M05 - colour: M009 - aluminum semi-matte
4. **Option with additional charge** - Mediabox M04 - 2xRJ45 (class E, cat. 6) +1xUSB + 4x230V, colour: M009 - aluminum semi-matte
5. **Option with additional charge** - Mediabox M04H - 2xRJ45 (class E, cat. 6) +1xUSB + 1xHDMI + 4x230V, colour: M009 - aluminum semi-matte

ATTENTION - cable grommets required for panel installation

WORKTOP - CONFIGURATIONS

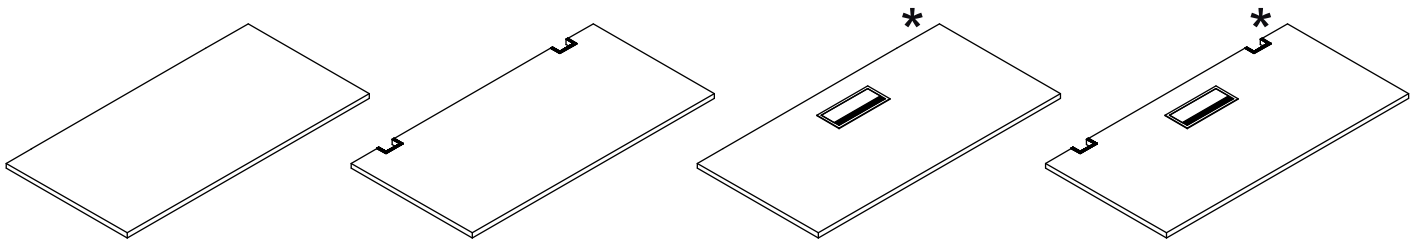

*Option with additional charge

FRAME

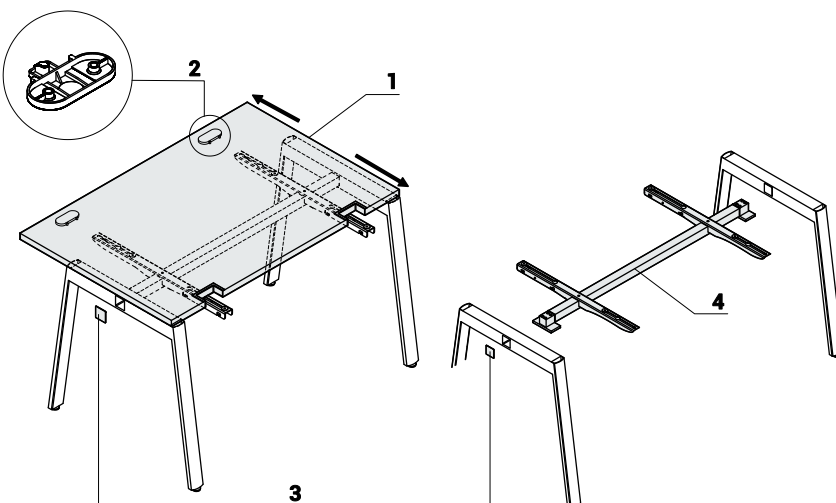

1. **Sliding top** - shifting range 180mm
2. **Release button**
3. **Covering cup** - PVC in frame colour
4. **Frame** - 40x40mm, assembled with one tool - universal for all YAN desks

TECHNICAL SPECIFICATION

FRAME

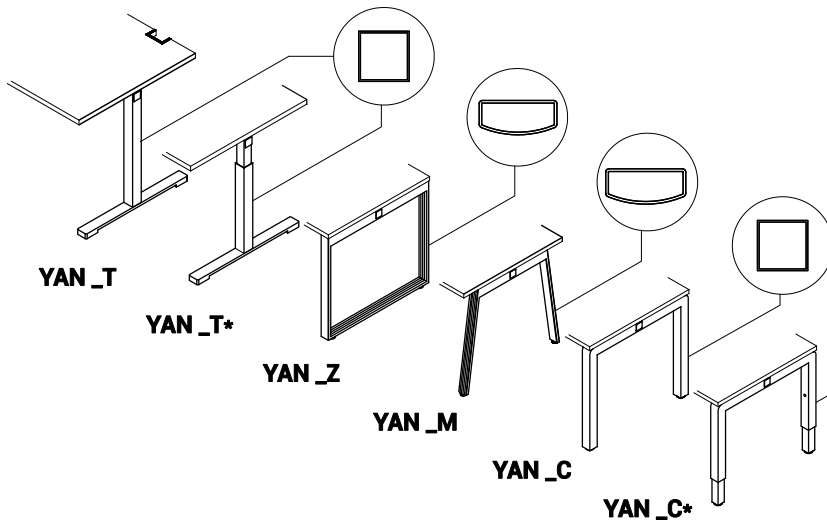

YAN T - powder coated steel, 60x60mm profile

*YAN T with manual height adjustment 640-840mm, every 20mm - powder painted steel, telescopic profile: 50x50 into 60x60mm

YAN Z - powder coated steel, 60x30mm profile

YAN M - powder coated steel, 60x30mm profile

YAN C - powder coated steel, 60x60mm profile

*YAN C with manual height adjustment 640-840mm, every 20mm - powder painted steel, telescopic profile: 50x50 into 60x60mm

HAND CRANK FRAME - DRIVE

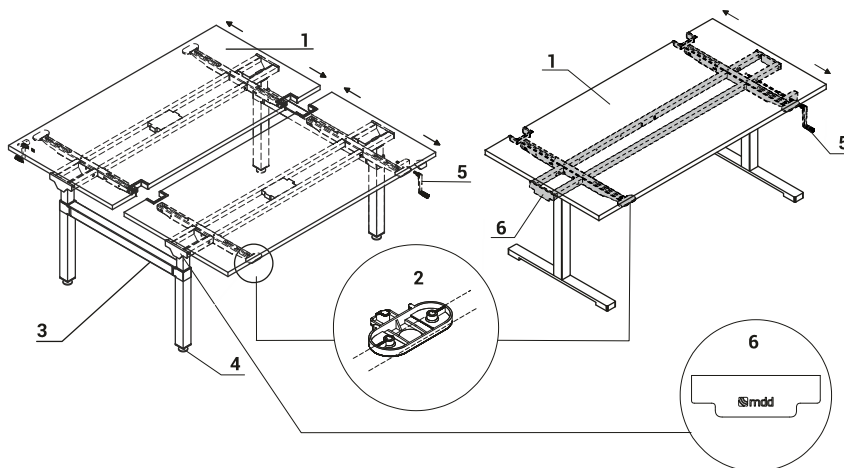

1. Sliding top - shifting range 180mm
2. Release button
3. Metal element for legs connecting
4. Leveling feet - range 5mm
5. Hand crank – hidden handle, flow regulation 650 - 1000mm, lifting capacity 100kg, frame profile 60x60 , 50x50
6. Covering plate

ELECTRIC HEIGHT ADJUSTABLE FRAME - DRIVE

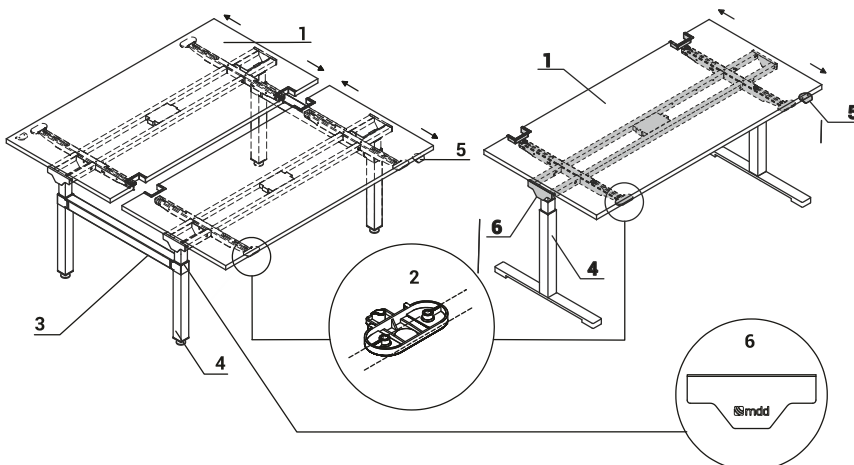

1. Sliding top - shifting range 180mm
2. Release button
3. Metal element for legs connecting
4. Electric height adjustable base - powder coated steel, load 100kg, telescopic leg 60/60, 50/50, 40/40mm
5. Control panel
6. Covering plate

TECHNICAL SPECIFICATION

ELECTRIC HEIGHT ADJUSTABLE FRAME - DRIVE

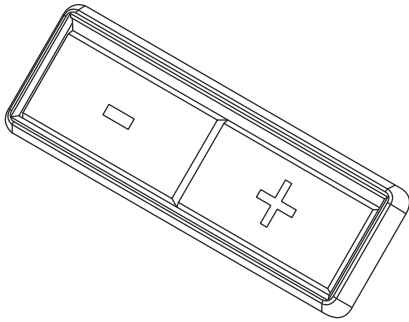

FRAME TECHNICAL SPECIFICATION

Height adjustment - 40mm/sec Super Soft Start - Stop

Drive - 2 synchronised motors with microprocessor, work control sensor

Noise level - <48dB

Anti colision mechanism

Control panel - electrical height adjustment - memory

Norms - ISO 21016, EN 527-2, EN 527 -3

EU Directives - 206/95EC, UI508 1999, UL 1004 R7 06, WE DC 2004/108WE

Power supply - 230V, 300W, power consumption on Standby - 0.3W

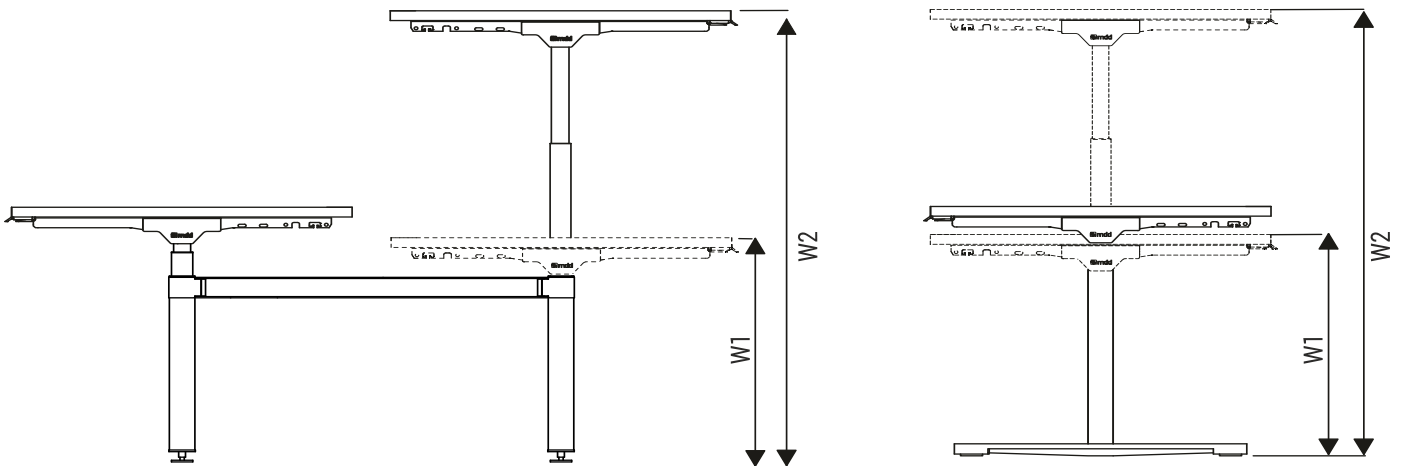

W1 - 650mm | W2 - 1300mm

TECHNICAL SPECIFICATION
DESK WITH MANAGERIAL STORAGE

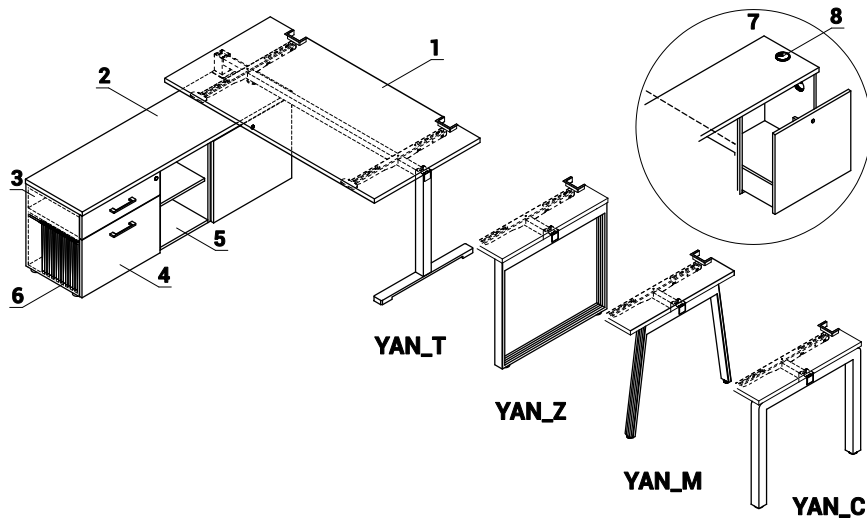

1. **Worktop** - MFC 28mm, PVC edge
2. **Top** - MFC 28mm, PVC edge
3. **Body** - MFC 18mm, PVC edge
4. **Front** - MFC 18mm,PVC edge
5. **Base** - MFC 18mm, PVC edge
6. **Suspension files drawer** - MFC 18mm, ball runners, max load 45kg, 100% extraction
7. **Drawer with bottom** - ball runners, max. load 40kg, 100 % extraction, push - to - open (possible storage of computer)
8. **Cable grommets** - Ø80mm

POSSIBLE CONFIGURATIONS

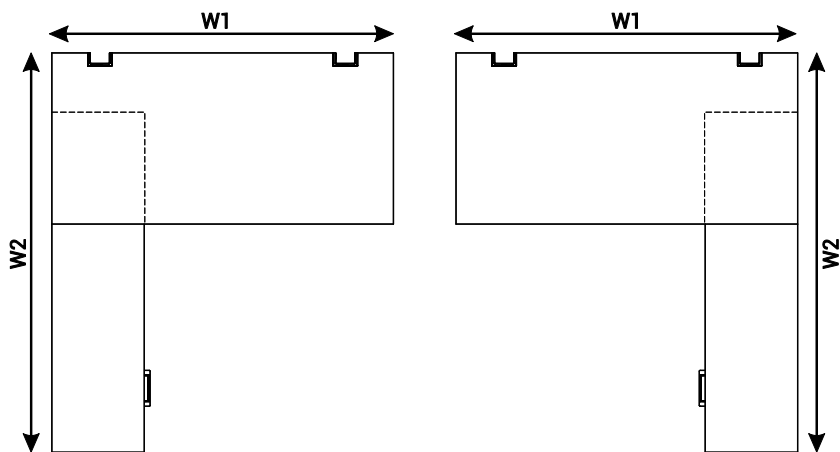

TECHNICAL SPECIFICATION

DESK EXTENSTIONS

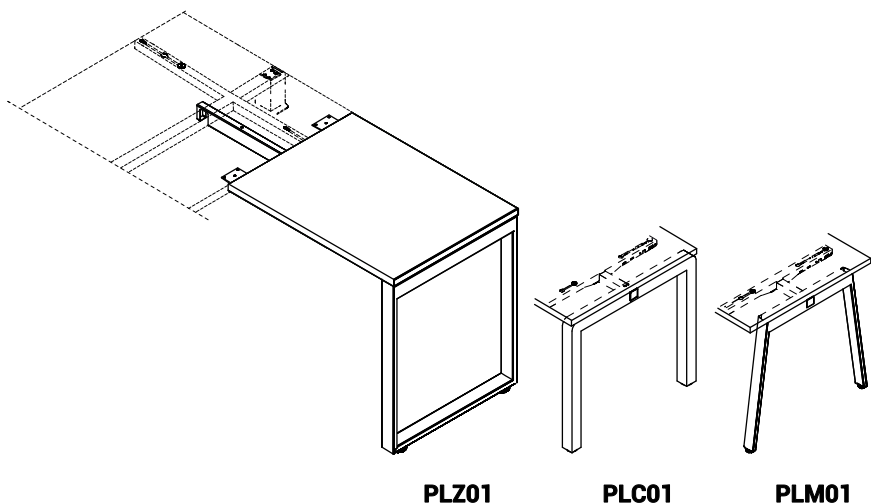

PLZ01- extension with sliding top, YAN Z base
PLC01 - extension with sliding top, YAN C base
PLM01- extension with sliding top, YAN M base

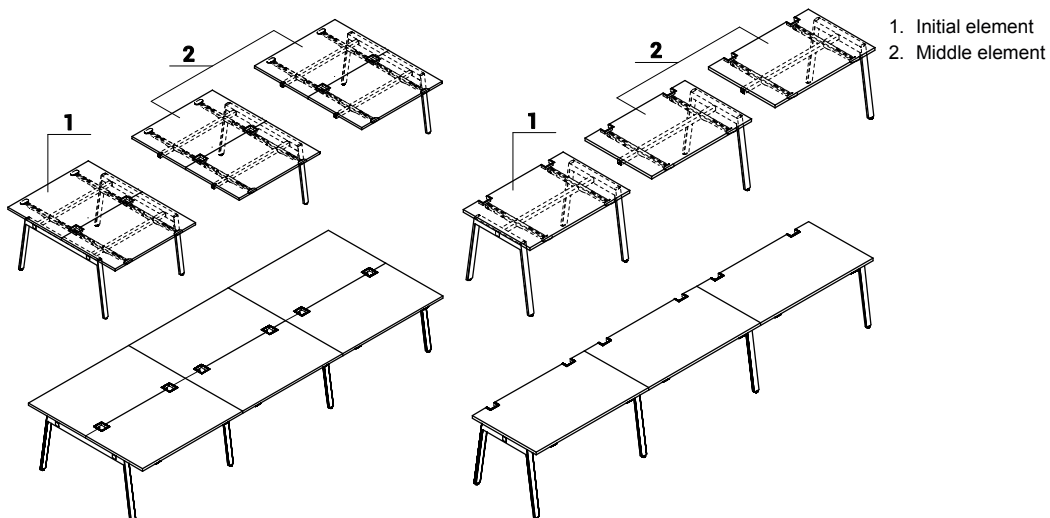

- 1. Initial element
- 2. Middle element

ATTENTION - the same for YAN programs

ACCESSORIES

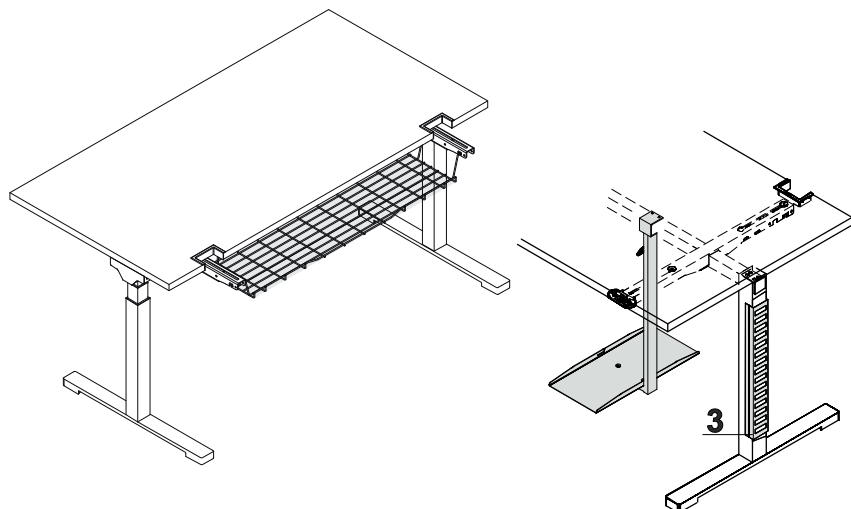

- 1. Horizontal cable tray - powder painted
- 2. CPU holder
- 3. Vertical cable management S93 - powder painted metal

TECHNICAL SPECIFICATION

CARGO PEDESTALS

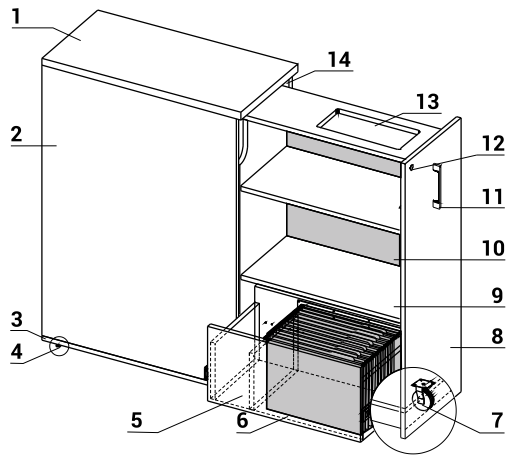

- 1. **Top** - MFC 28mm, PVC edge
- 2. **Body** - MFC 18mm, PVC edge
- 3. **Base** - MFC 18mm, PVC edge
- 4. **Leveling** - 10mm range
- 5. Movable vertical partition which allows organize the space
- 6. **Drawer** - MFC 18 mm, max. 35kg load, possible extraction 100%, possibility of hanging files, ball runners
- 7. **Castors** - Ø75mm
- 8. **Front** - MFC 18mm,PVC edge
- 9. **Shelf** - MFC 18mm, PVC edge
- 10. **Full back rear** - MFC 18 mm
- 11. **Aluminum handle**
- 12. **Patent lock**
- 13. **Pencil tray** - black plastic
- 14. **Back MFC** - 18mm, PVC edges

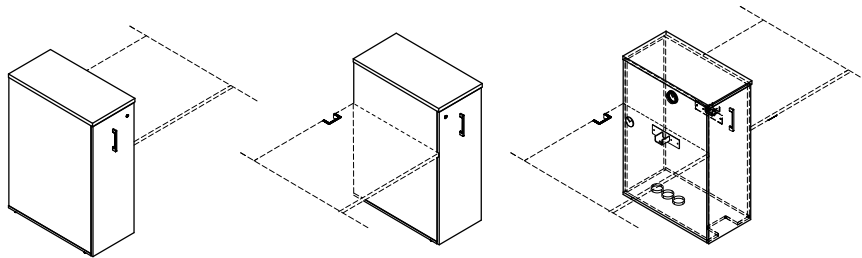

- KCD80L** - access to shelves from left side
- KCD80P** - access to shelves from right side
- KCD80SP** - access to shelves from right side, cable management inside the cargo pedestal
- KCD80SL** - access to shelves from right side, cable management inside the cargo pedestal

KCD80L

KCD80P

KCD80SL / KCD80SP

POSSIBLE CONFIGURATIONS

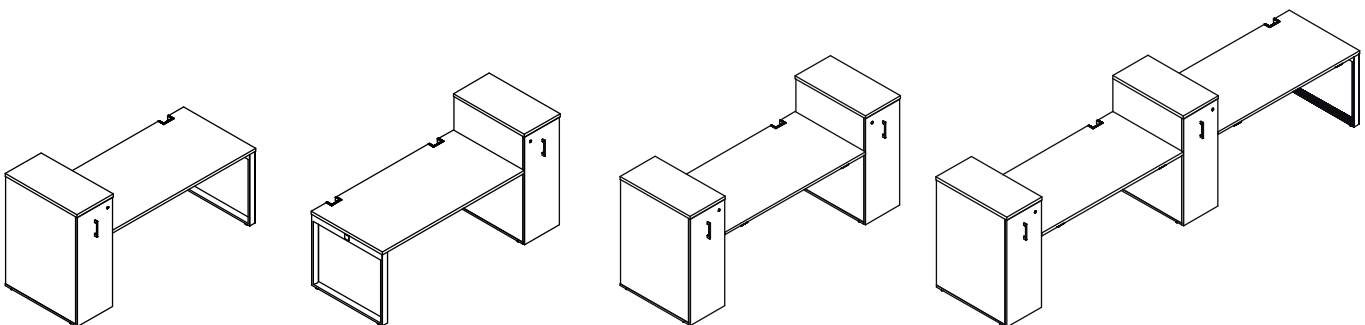

TECHNICAL SPECIFICATION

KDT PEDESTALS

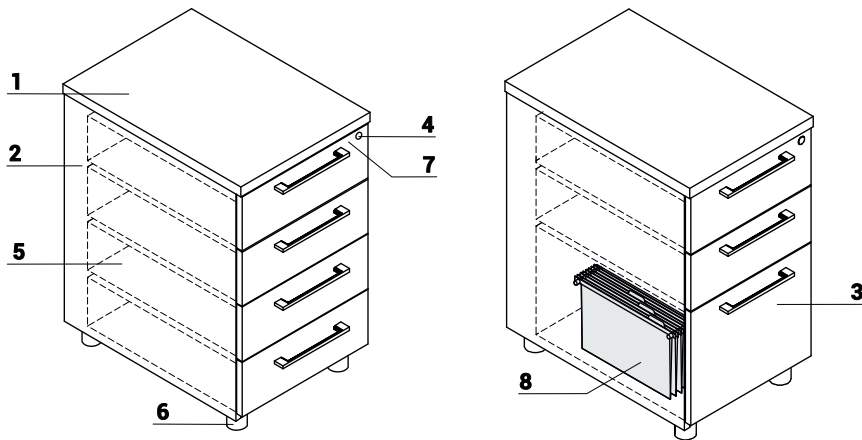

- 1. **Top** - MFC 28mm, PVC edge
- 2. **Body** - MFC 18mm, PVC edge
- 3. **Front** - MFC 18mm, PVC edge
- 4. **Central lock** - foldable key
- 5. **Metal drawer** - roll runners, max load 25kg, 80% extraction; Anti - tilt mechanism; OPTIONAL: ball runners, soft closing
- 6. **Leveling** - 5mm range
- 7. **Pencil tray** - black plastic
- 8. **Suspension files drawer** - ball runners, max load 30kg, 100% extraction, A4 folders must be inserted parallelly to the front

KDT..L

KDT..P

KDT..LP

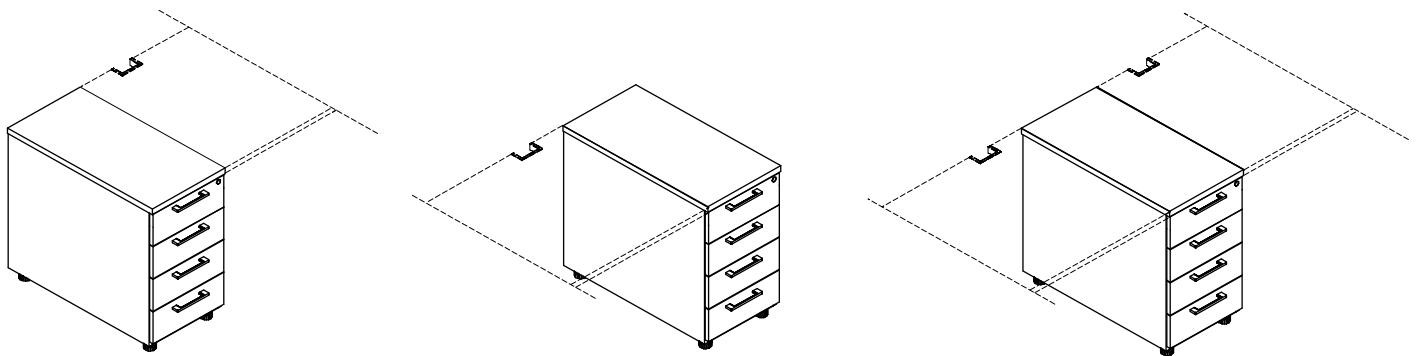

POSSIBLE CONFIGURATIONS

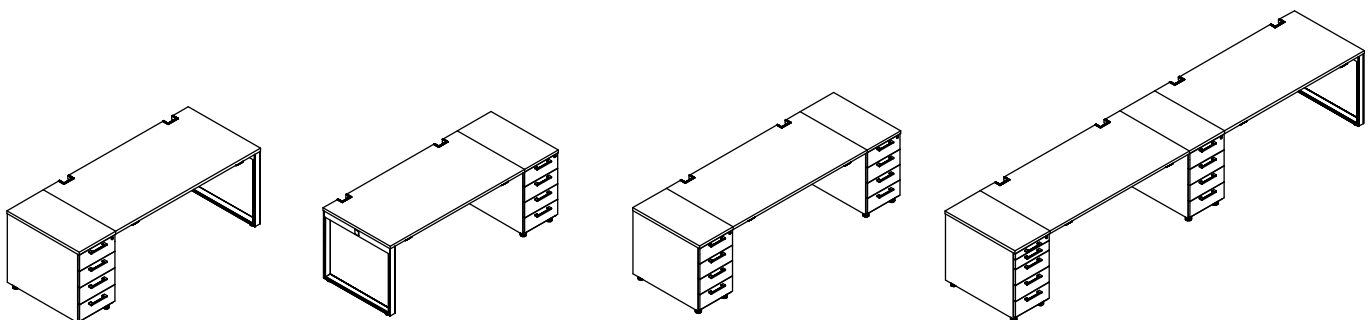

TECHNICAL SPECIFICATION

KRT PEDESTALS

1. **Top** - MFC 28mm, PVC edge
2. **Body** - MFC 18mm, PVC edge
3. **Front** - MFC 18mm, PVC edge
4. **Central lock** - foldable key
5. **Metal drawer** - roll runners, max load 25kg, 80% extraction; Anti - tilt mechanism; OPTIONAL: ball runners, soft closing
6. **Leveling** - 5mm range
7. **Separate pencil drawer**
8. **Suspension files drawer** - ball runners, max load 30kg, 100% extraction, A4 folders must be inserted parallelly to the front

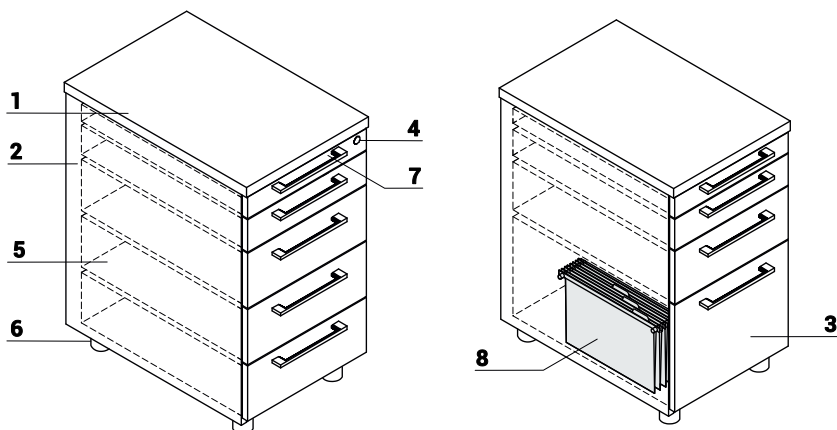

KRT..L

KRT..P

KRT..LP

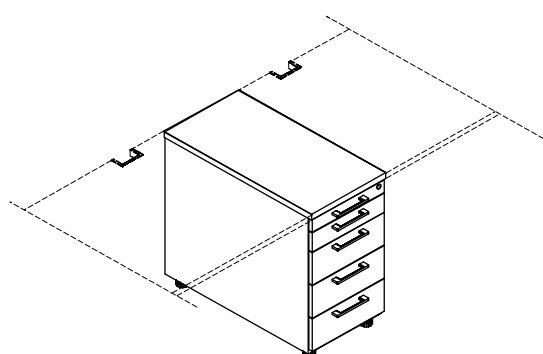
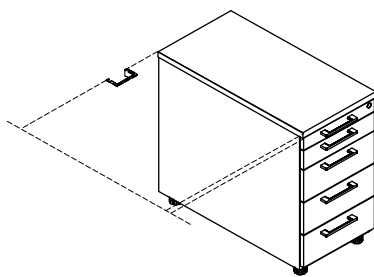
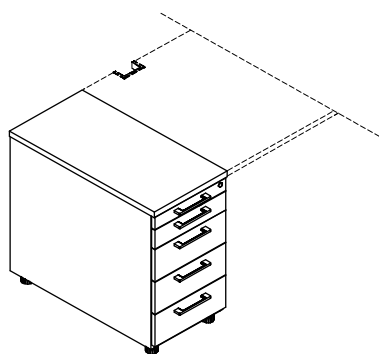

POSSIBLE CONFIGURATIONS

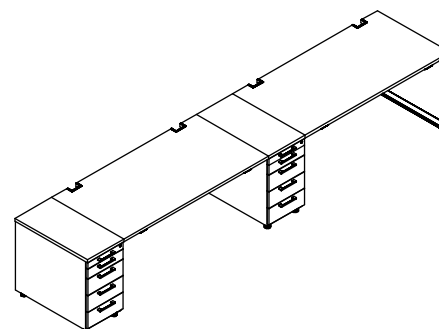
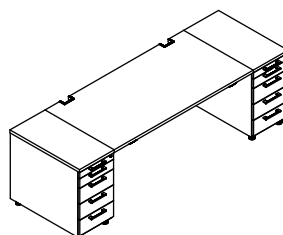
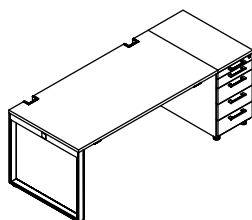
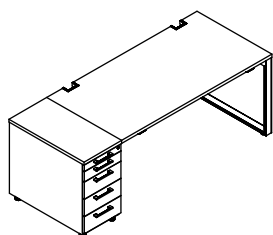

TECHNICAL SPECIFICATION

YAN STORAGES

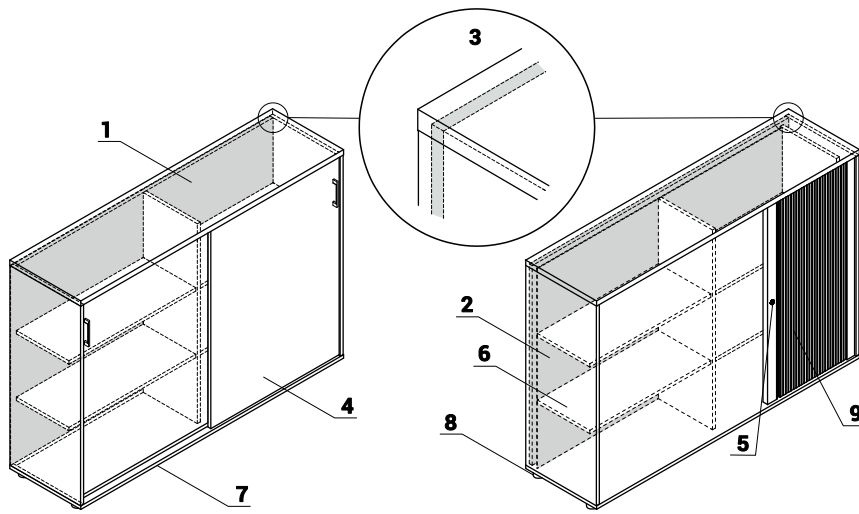

- 1. **Top** - MFC 28mm, PVC edge
- 2. **Body** - MFC 18mm, PVC edge
- 3. **Back MFC** - 18mm, PVC edges
- 4. **Sliding front** - MFC 18mm, PVC edge
- 5. **Patent lock**
- 6. **Shelf** - MFC 18mm, PVC edge
- 7. **Base** - MFC 18mm, PVC edge
- 8. **Leveling feet 27mm** - range 12mm
- 9. **Front** - tambour



BA3P08

BA2P08

BA3L08

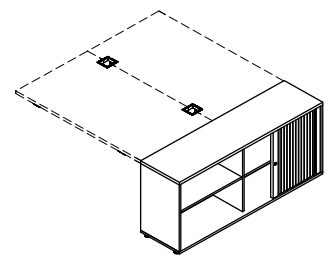
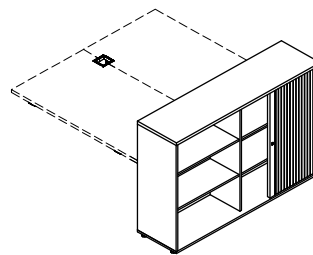
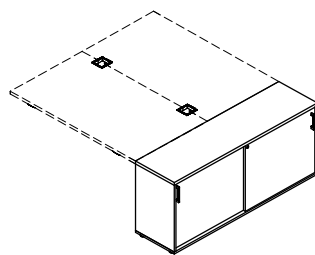
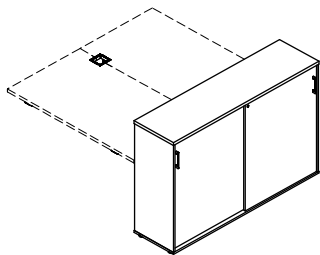
BA2L08



PRODUCT ILLUSTRATION	DIMENSIONS [mm]			INDEX SYMBOL						COMMENTS
	WIDTH	DEPTH	HEIGHT			kg	m3	pcs		

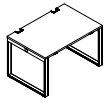
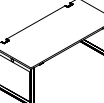

DESKS

	1200	800	740	ZBN02		46.0	0.143	5		
	1400	800	740	ZBN04		48.0	0.149	5		
	1600	800	740	ZBN06		52.0	0.155	5		
	1800	800	740	ZBN08		55.0	0.162	5		

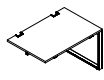
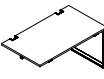
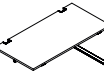
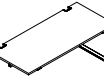

ELEMENTS FOR DESKS PAIRING



	1200	800	740	ZBN02L		37.0	0.093	4		Fixing only for edges 800mm
	1400	800	740	ZBN04L		39.0	0.099	4		Fixing only for edges 800mm
	1600	800	740	ZBN06L		43.0	0.105	4		Fixing only for edges 800mm
	1800	800	740	ZBN08L		46.0	0.112	4		Fixing only for edges 800mm

ADDITIONAL CHARGE

FEATURE	PRODUCT											COMMENTS
	ZBN02	ZBN04	ZBN06	ZBN08	ZBN02L	ZBN04L	ZBN06L	ZBN08L	kg	m3	pcs	
MEDIABOX M04H									0.1	0.0001	1	
MEDIABOX M04									0.9	0.0070	1	
TOP ACCESS M05									0.9	0.0070	1	

DESCRIPTION



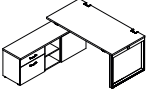
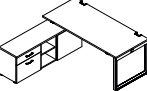
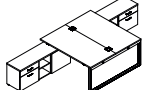
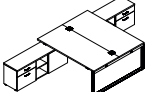

 - NET WEIGHT VOLUME NUMBER OF PACKAGES

PRODUCT ILLUSTRATION	DIMENSIONS [mm]			INDEX SYMBOL						COMMENTS
	WIDTH	DEPTH	HEIGHT			kg	m3	pcs		



DESKS WITH MANAGERIAL SIDE STORAGE

	1600	1870	740	ZBN01		122.0	0.483	9		universal left/right
	1800	1870	740	ZBN03		125.0	0.489	9		universal left/right
	1600	3740	740	ZBN05		238.0	0.983	16		
	1800	3740	740	ZBN07		244.0	0.996	16		

BENCH DESKS

	1200	1600	740	ZBN12		80.0	0.321	7		
	1400	1600	740	ZBN14		84.0	0.333	7		
	1600	1600	740	ZBN16		92.0	0.345	7		
	1800	1600	740	ZBN18		98.0	0.358	7		

ADDITIONAL CHARGE



FEATURE	PRODUCT											COMMENTS
	ZBN01	ZBN03	ZBN05	ZBN07	ZBN12	ZBN14	ZBN16	ZBN18	kg	m3	pcs	
MEDIABOX M04H									0.1	0.0001	1	
MEDIABOX M04									0.9	0.0070	1	
TOP ACCESS M05									0.9	0.0070	1	
II PRICE GROUP									0.0	0.0000	0	

DESCRIPTION





 - NET WEIGHT

 VOLUME



 NUMBER OF PACKAGES

PRODUCT ILLUSTRATION	DIMENSIONS [mm]			INDEX SYMBOL					COMMENTS
	WIDTH	DEPTH	HEIGHT			kg	m3	pcs	



ELEMENTS FOR DESKS PAIRING

	1200	1600	740	ZBN12L		68.0	0.204	6	
	1400	1600	740	ZBN14L		72.0	0.216	6	
	1600	1600	740	ZBN16L		80.0	0.228	6	
	1800	1600	740	ZBN18L		86.0	0.241	6	



DESK EXTENSTIONS



	1600	600	28	PL180		33.0	0.051	3	
	600	800	740	PLZ01		23.2	0.051	5	

ADDITIONAL CHARGE

FEATURE	PRODUCT											COMMENTS
	ZBN12L	ZBN14L	ZBN16L	ZBN18L					kg	m3	pcs	
MEDIABOX M04H									0.1	0.0001	1	
MEDIABOX M04									0.9	0.0070	1	
TOP ACCESS M05									0.9	0.0070	1	

DESCRIPTION

 - NET WEIGHT VOLUME NUMBER OF PACKAGES

PRODUCT ILLUSTRATION	DIMENSIONS [mm]			INDEX SYMBOL					COMMENTS
	WIDTH	DEPTH	HEIGHT			kg	m3	pcs	

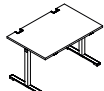
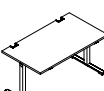
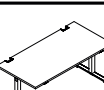
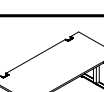

DESKS

	1200	800	740	BRN02		36.0	0.056	5	
	1400	800	740	BRN04		38.0	0.062	5	
	1600	800	740	BRN06		42.0	0.068	5	
	1800	800	740	BRN08		45.0	0.074	5	

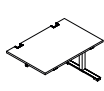
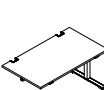
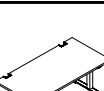
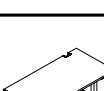

ELEMENTS FOR DESKS PAIRING



	1200	800	740	BRN02L		32.5	0.050	5	Fixing only for edges 800mm
	1400	800	740	BRN04L		34.5	0.056	5	Fixing only for edges 800mm
	1600	800	740	BRN06L		38.5	0.062	5	Fixing only for edges 800mm
	1800	800	740	BRN08L		41.5	0.069	5	Fixing only for edges 800mm

ADDITIONAL CHARGE

FEATURE	PRODUCT											COMMENTS
	BRN02	BRN04	BRN06	BRN08	BRN02L	BRN04L	BRN06L	BRN08L	kg	m3	pcs	
MEDIABOX M04H									0.1	0.0001	1	
MEDIABOX M04									0.9	0.0070	1	
TOP ACCESS M05									0.9	0.0070	1	

DESCRIPTION

 - NET WEIGHT VOLUME NUMBER OF PACKAGES

PRODUCT ILLUSTRATION	DIMENSIONS [mm]			INDEX SYMBOL						COMMENTS
	WIDTH	DEPTH	HEIGHT			kg	m3	pcs		

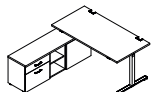
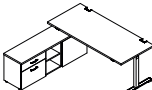
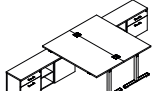
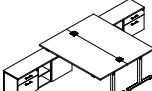

DESKS WITH MANAGERIAL SIDE STORAGE

	1600	1870	740	BRN01		117.5	0.440	10		universal left/right
	1800	1870	740	BRN03		120.5	0.446	10		universal left/right
	1600	3740	740	BRN05		234.0	0.878	17		
	1800	3740	740	BRN07		240.0	0.891	17		

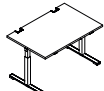
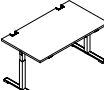
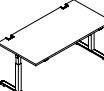
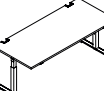

DESKS WITH MANUAL HEIGHT ADJUSTMENT



	1200	800	640 840	BRN02R		41.0	0.056	5		height regulation 640 - 860mm, every 20mm
	1400	800	640 840	BRN04R		43.0	0.062	5		height regulation 640 - 860mm, every 20mm
	1600	800	640 840	BRN06R		47.0	0.068	5		height regulation 640 - 860mm, every 20mm
	1800	800	640 840	BRN08R		50.0	0.074	5		height regulation 640 - 860mm, every 20mm

ADDITIONAL CHARGE

FEATURE	PRODUCT											COMMENTS
	BRN01	BRN03	BRN05	BRN07	BRN02R	BRN04R	BRN06R	BRN08R	kg	m3	pcs	
MEDIABOX M04H									0.1	0.0001	1	
MEDIABOX M04									0.9	0.0070	1	
TOP ACCESS M05									0.9	0.0070	1	
II PRICE GROUP									0.0	0.0000	0	

DESCRIPTION



 - NET WEIGHT VOLUME NUMBER OF PACKAGES

PRODUCT ILLUSTRATION	DIMENSIONS [mm]			INDEX SYMBOL						COMMENTS
	WIDTH	DEPTH	HEIGHT			kg	m3	pcs		

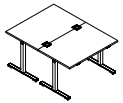
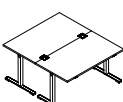
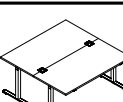
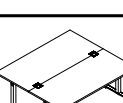

BENCH DESKS

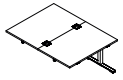
	1200	1600	740	BRN12		72.0	0.111	9		
	1400	1600	740	BRN14		76.0	0.124	9		
	1600	1600	740	BRN16		84.0	0.135	9		
	1800	1600	740	BRN18		90.0	0.149	9		

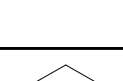
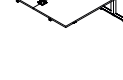

ELEMENTS FOR DESKS PAIRING



	1200	1600	740	BRN12L		64.0	0.099	7		
	1400	1600	740	BRN14L		68.0	0.111	7		
	1600	1600	740	BRN16L		76.0	0.123	7		
	1800	1600	740	BRN18L		82.0	0.136	7		

ADDITIONAL CHARGE

FEATURE	PRODUCT											COMMENTS
	BRN12	BRN14	BRN16	BRN18	BRN12L	BRN14L	BRN16L	BRN18L	kg	m3	pcs	
MEDIABOX M04H									0.1	0.0001	1	
MEDIABOX M04									0.9	0.0070	1	
TOP ACCESS M05									0.9	0.0070	1	

DESCRIPTION

 - NET WEIGHT VOLUME NUMBER OF PACKAGES

PRODUCT ILLUSTRATION	DIMENSIONS [mm]			INDEX SYMBOL					COMMENTS
	WIDTH	DEPTH	HEIGHT			kg	m3	pcs	

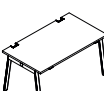
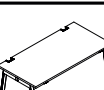
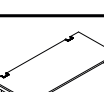

DESKS

	1200	800	740	BLN02		44.0	0.134	5	
	1400	800	740	BLN04		46.0	0.140	5	
	1600	800	740	BLN06		50.0	0.146	5	
	1800	800	740	BLN08		53.0	0.153	5	

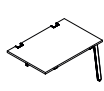
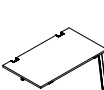
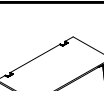
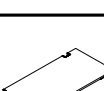

ELEMENTS FOR DESKS PAIRING



	1200	800	740	BLN02L		36.0	0.089	4	Fixing only for edges 800mm
	1400	800	740	BLN04L		38.0	0.095	4	Fixing only for edges 800mm
	1600	800	740	BLN06L		42.0	0.101	4	Fixing only for edges 800mm
	1800	800	740	BLN08L		45.0	0.107	4	Fixing only for edges 800mm

ADDITIONAL CHARGE

FEATURE	PRODUCT											COMMENTS
	BLN02	BLN04	BLN06	BLN08	BLN02L	BLN04L	BLN06L	BLN08L	kg	m3	pcs	
MEDIABOX M04H									0.1	0.0001	1	
MEDIABOX M04									0.9	0.0070	1	
TOP ACCESS M05									0.9	0.0070	1	

DESCRIPTION



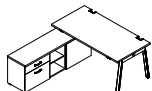
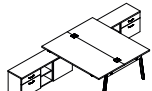

 - NET WEIGHT VOLUME NUMBER OF PACKAGES

PRODUCT ILLUSTRATION	DIMENSIONS [mm]			INDEX SYMBOL						COMMENTS
	WIDTH	DEPTH	HEIGHT			kg	m3	pcs		



DESKS WITH MANAGERIAL SIDE STORAGE

	1600	1870	740	BLN01		121.0	0.478	9		universal left/right
	1800	1870	740	BLN03		124.0	0.485	9		universal left/right
	1600	3740	740	BLN05		238.0	0.941	16		
	1800	3740	740	BLN07		244.0	0.954	16		

BENCH DESKS

	1200	1600	740	BLN12		80.0	0.237	7		
	1400	1600	740	BLN14		84.0	0.250	7		
	1600	1600	740	BLN16		92.0	0.261	7		
	1800	1600	740	BLN18		98.0	0.275	7		

ADDITIONAL CHARGE



FEATURE	PRODUCT											COMMENTS
	BLN01	BLN03	BLN05	BLN07	BLN12	BLN14	BLN16	BLN18	kg	m3	pcs	
MEDIABOX M04H									0.1	0.0001	1	
MEDIABOX M04									0.9	0.0070	1	
TOP ACCESS M05									0.9	0.0070	1	
II PRICE GROUP									0.0	0.0000	0	

DESCRIPTION





 - NET WEIGHT

 VOLUME



 NUMBER OF PACKAGES

PRODUCT ILLUSTRATION	DIMENSIONS [mm]			INDEX SYMBOL						COMMENTS
	WIDTH	DEPTH	HEIGHT			kg	m3	pcs		



ELEMENTS FOR DESKS PAIRING

	1200	1600	740	BLN12L		68.0	0.162	6		
	1400	1600	740	BLN14L		72.0	0.174	6		
	1600	1600	740	BLN16L		80.0	0.186	6		
	1800	1600	740	BLN18L		86.0	0.199	6		

DESK EXTENSTIONS

	1600	600	28	PL180		33.0	0.051	3		
	600	800	740	PLM01		22.0	0.057	5		

ADDITIONAL CHARGE



FEATURE	PRODUCT											COMMENTS
	BLN12L	BLN14L	BLN16L	BLN18L					kg	m3	pcs	
MEDIABOX M04H									0.1	0.0001	1	
MEDIABOX M04									0.9	0.0070	1	
TOP ACCESS M05									0.9	0.0070	1	

DESCRIPTION

 - NET WEIGHT

 VOLUME



 NUMBER OF PACKAGES

PRODUCT ILLUSTRATION	DIMENSIONS [mm]			INDEX SYMBOL					COMMENTS
	WIDTH	DEPTH	HEIGHT			kg	m3	pcs	

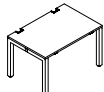
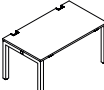
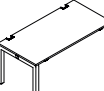
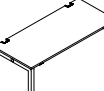

DESKS

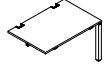
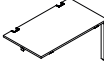
	1200	800	740	BUN19		38.0	0.126	4	
	1400	800	740	BUN20		40.0	0.132	4	
	1600	800	740	BUN21		44.0	0.138	4	
	1800	800	740	BUN22		47.0	0.145	4	

ELEMENTS FOR DESKS PAIRING



	1200	800	740	BUN02L		33.0	0.084	4	Fixing only for edges 800mm
	1400	800	740	BUN04L		35.0	0.091	4	Fixing only for edges 800mm
	1600	800	740	BUN06L		39.0	0.096	4	Fixing only for edges 800mm
	1800	800	740	BUN08L		42.0	0.103	4	Fixing only for edges 800mm

ADDITIONAL CHARGE

FEATURE	PRODUCT											COMMENTS
	BUN19	BUN20	BUN21	BUN22	BUN02L	BUN04L	BUN06L	BUN08L	kg	m3	pcs	
MEDIABOX M04H									0.1	0.0001	1	
MEDIABOX M04									0.9	0.0070	1	
TOP ACCESS M05									0.9	0.0070	1	

DESCRIPTION

 - NET WEIGHT VOLUME NUMBER OF PACKAGES

PRODUCT ILLUSTRATION	DIMENSIONS [mm]			INDEX SYMBOL						COMMENTS
	WIDTH	DEPTH	HEIGHT			kg	m3	pcs		

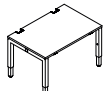
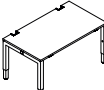
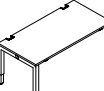
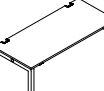

DESKS WITH MANUAL HEIGHT ADJUSTMENT

	1200	800	640 840	BUN19R		40.0	0.126	4		height regulation 640 - 860mm, every 20mm
	1400	800	640 840	BUN20R		42.0	0.132	4		height regulation 640 - 860mm, every 20mm
	1600	800	640 840	BUN21R		46.0	0.138	4		height regulation 640 - 860mm, every 20mm
	1800	800	640 840	BUN22R		49.0	0.145	4		height regulation 640 - 860mm, every 20mm

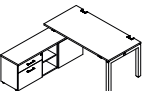
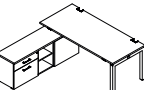
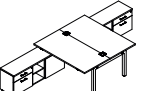
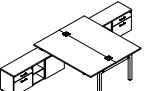
DESKS WITH MANAGERIAL SIDE STORAGE

	1600	1870	740	BUN01		118.0	0.474	9		universal left/right
	1800	1870	740	BUN03		121.0	0.481	9		universal left/right
	1600	3740	740	BUN05		234.0	0.918	16		
	1800	3740	740	BUN07		240.0	0.932	16		

ADDITIONAL CHARGE



FEATURE	PRODUCT											COMMENTS
	BUN19R	BUN20R	BUN21R	BUN22R	BUN01	BUN03	BUN05	BUN07	kg	m3	pcs	
MEDIABOX M04H									0.1	0.0001	1	
MEDIABOX M04									0.9	0.0070	1	
TOP ACCESS M05									0.9	0.0070	1	
II PRICE GROUP									0.0	0.0000	0	

DESCRIPTION





 - NET WEIGHT

 VOLUME





 NUMBER OF PACKAGES

PRODUCT ILLUSTRATION	DIMENSIONS [mm]			INDEX SYMBOL					COMMENTS
	WIDTH	DEPTH	HEIGHT			kg	m3	pcs	



BENCH DESKS

	1200	1600	740	BUN12		71.0	0.192	6	
	1400	1600	740	BUN14		75.0	0.205	6	
	1600	1600	740	BUN16		83.0	0.216	6	
	1800	1600	740	BUN18		89.0	0.229	6	



ELEMENTS FOR DESKS PAIRING



	1200	1600	740	BUN12L		64.0	0.139	6	
	1400	1600	740	BUN14L		68.0	0.152	6	
	1600	1600	740	BUN16L		76.0	0.163	6	
	1800	1600	740	BUN18L		82.0	0.177	6	

ADDITIONAL CHARGE



FEATURE	PRODUCT											COMMENTS
	BUN12	BUN14	BUN16	BUN18	BUN12L	BUN14L	BUN16L	BUN18L	kg	m3	pcs	
MEDIABOX M04H									0.1	0.0001	1	
MEDIABOX M04									0.9	0.0070	1	
TOP ACCESS M05									0.9	0.0070	1	

DESCRIPTION

 - NET WEIGHT VOLUME NUMBER OF PACKAGES

PRODUCT ILLUSTRATION	DIMENSIONS [mm]			INDEX SYMBOL						COMMENTS
	WIDTH	DEPTH	HEIGHT			kg	m3	pcs		

DESK EXTENSTIONS



	1600	600	28	PL180		33.0	0.051	3		
	600	800	740	PLC01		22.0	0.057	5		

DESCRIPTION







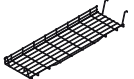
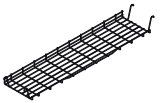
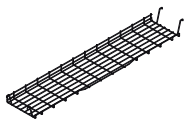

 - NET WEIGHT

 VOLUME

 NUMBER OF PACKAGES

PRODUCT ILLUSTRATION	DIMENSIONS [mm]			INDEX SYMBOL						COMMENTS
	WIDTH	DEPTH	HEIGHT			kg	m3	pcs		

ACCESSORIES



	716	244	98	S120		0.9	0.018	1		For 1200mm wide desks
	916	244	98	S140		1.2	0.023	1		For 1400mm wide desks
	1116	244	98	S160		1.4	0.028	1		For 1600mm wide desks
	1316	244	98	S180		1.7	0.033	1		For 1800mm wide desks
	275	120	140	M04		0.0	0.001	0		4x230V, 2xRJ45, 1xUSB
	275	120	140	M04H		0.0	0.001	0		4x230V, 2xRJ45, 1xUSB, 1xHDMI
	275	120	25	M05		0.3	0.002	1		TOP ACCESS
	140	70	750	S81		1.1	0.008	1		vertical cable duct in colour: 09 - aluminum
	140	140	750	S94		1.0	0.004	1		vertical cable duct - colour: 09 - aluminum
	470	62	34	S93		1.0	0.002	1		vertical cable organizer, fits to desks DRIVE, YAN, OGIA, OGIQ and OGI U (width profile 60mm)
	1000	70	35	S82		1.0	0.005	1		cable rack bracket to install cables under desktop, 09 - aluminum

DESCRIPTION





 - NET WEIGHT

 VOLUME

 NUMBER OF PACKAGES

PRODUCT ILLUSTRATION	DIMENSIONS [mm]			INDEX SYMBOL						COMMENTS
	WIDTH	DEPTH	HEIGHT			kg	m3	pcs		

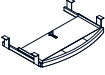
ACCESSORIES



	212	460	600	S87		2.7	0.029	1		CPU holder, colour: M009 - aluminium semi - matte, M015 - metal white semi - matte, M154 - anthracite semi - matte
	220	470	148	S73		3.2	0.002	1		computer stand (wheels) 26 - aluminium
	610	400	85	C01		0.5	0.010	1		keyboard shelf for desks 800mm deep, 02 grey, except from DRIVE desks
	45	50	57	S11		0.0	0.001	0		handbag hanger, colour: M015 - white semi-matte

DESCRIPTION



 - NET WEIGHT

 VOLUME

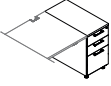

 NUMBER OF PACKAGES

PRODUCT ILLUSTRATION	DIMENSIONS [mm]			INDEX SYMBOL						COMMENTS
	WIDTH	DEPTH	HEIGHT			kg	m3	pcs		

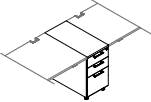
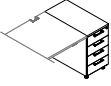
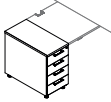
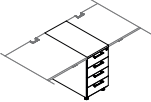
KDT PEDESTALS

	402	800	740	KDT73P		32.0	0.257	2		right
	402	800	740	KDT73L		32.0	0.257	2		left
	402	800	740	KDT73LP		33.0	0.259	3		middle
	402	800	740	KDT74P		32.0	0.257	2		right
	402	800	740	KDT74L		32.0	0.257	2		left
	402	800	740	KDT74LP		33.0	0.259	3		middle

ADDITIONAL CHARGE



FEATURE	PRODUCT										COMMENTS
	KDT73P	KDT73L	KDT73LP	KDT74P	KDT74L	KDT74LP		kg	m3	pcs	
II PRICE GROUP								0.0	0.0000	0	
SELF CLOSING SYSTEM								1.0	0.0010	1	
BALL RUNNERS								1.0	0.0010	1	

DESCRIPTION

 - NET WEIGHT

 VOLUME



 NUMBER OF PACKAGES

PRODUCT ILLUSTRATION	DIMENSIONS [mm]			INDEX SYMBOL						COMMENTS
	WIDTH	DEPTH	HEIGHT			kg	m3	pcs		

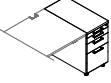
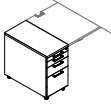
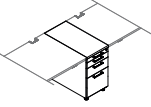
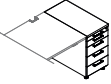
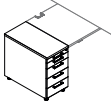
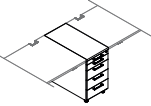
KRT PEDESTALS

	402	800	740	KRT73P		32.0	0.257	2		right
	402	800	740	KRT73L		32.0	0.257	2		left
	402	800	740	KRT73LP		33.0	0.259	3		middle
	402	800	740	KRT74P		32.0	0.257	2		right
	402	800	740	KRT74L		32.0	0.257	2		left
	402	800	740	KRT74LP		33.0	0.259	3		middle

ADDITIONAL CHARGE



FEATURE	PRODUCT										COMMENTS
	KRT73P	KRT73L	KRT73LP	KRT74P	KRT74L	KRT74LP		kg	m3	pcs	
II PRICE GROUP								0.0	0.0000	0	
SELF CLOSING SYSTEM								1.0	0.0010	1	
BALL RUNNERS								1.0	0.0010	1	

DESCRIPTION

 - NET WEIGHT

 VOLUME

 NUMBER OF PACKAGES

PRODUCT ILLUSTRATION	DIMENSIONS [mm]			INDEX SYMBOL						COMMENTS
	WIDTH	DEPTH	HEIGHT			kg	m3	pcs		

CARGO PEDESTALS

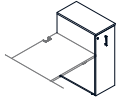
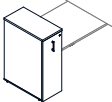
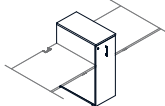
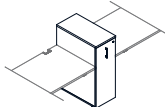
	402	800	1129	KCD80P		72.0	0.416	2		right
	402	800	1129	KCD80L		74.0	0.416	2		left
	402	800	1129	KCD80SP		75.0	0.418	3		middle - shelves accesable from right side
	402	800	1129	KCD80SL		75.0	0.418	3		middle - shelves accesable from left side

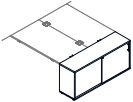
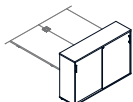

SLIDING DOOR STORAGES

	1600	432	740	BA2P08		70.0	0.185	6		with double tops only
	1600	432	1129	BA3P08		95.0	0.263	6		with double tops only

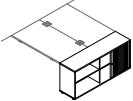
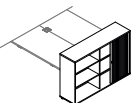
TAMBOUR STORAGES

	1600	432	740	BA2L08		62.0	0.649	4		with double tops only
	1600	432	1129	BA3L08		83.0	0.927	4		with double tops only

ADDITIONAL CHARGE



FEATURE	PRODUCT											COMMENTS
	KCD80P	KCD80L	KCD80SP	KCD80SL	BA2P08	BA3P08	BA2L08	BA3L08	kg	m3	pcs	
II PRICE GROUP									0.0	0.0000	0	
DRAWER									1.0	0.0010	1	
METAL KICK PLATE									0.0	0.0000	0	

DESCRIPTION

 - NET WEIGHT

 VOLUME

 NUMBER OF PACKAGES

PRODUCT ILLUSTRATION	DIMENSIONS [mm]			INDEX SYMBOL						COMMENTS
	WIDTH	DEPTH	HEIGHT			kg	m3	pcs		



HANDLES

	160	110	20	HST2		0.2	0.000	1		handles STANDARD (2pcs)
---	-----	-----	----	-------------	--	-----	-------	---	--	-------------------------

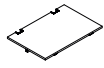
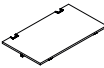
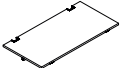
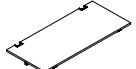

SINGLE DESK TOPS

	1200	800	83	BZB02		28.0	0.043	3		
	1400	800	83	BZB04		30.0	0.049	3		
	1600	800	83	BZB06		34.0	0.055	3		
	1800	800	83	BZB08		37.0	0.062	3		

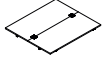
DOUBLE DESK TOPS

	1200	1600	83	BZB12		56.0	0.086	5		
	1400	1600	83	BZB14		60.0	0.099	5		
	1600	1600	83	BZB16		68.0	0.110	5		
	1800	1600	83	BZB18		74.0	0.124	5		

ADDITIONAL CHARGE

FEATURE	PRODUCT												COMMENTS
	BZB02	BZB04	BZB06	BZB08	BZB12	BZB14	BZB16	BZB18		kg	m3	pcs	
MEDIABOX M04H										0.1	0.0001	1	
MEDIABOX M04										0.9	0.0070	1	
TOP ACCESS M05										0.9	0.0070	1	

DESCRIPTION

 - NET WEIGHT

 VOLUME

 NUMBER OF PACKAGES