

TECHNICAL SPECIFICATION

COLOURS

MFC ELEMENTS



31 CANADIAN OAK



34 CHESTNUT



106 LOWLAND NUT



COLUMN COLOUR



M115 BLACK
SEMI-MATTE



M009 ALUMINUM
SEMI-MATTE



M015 WHITE
SEMI-MATTE



DESKS

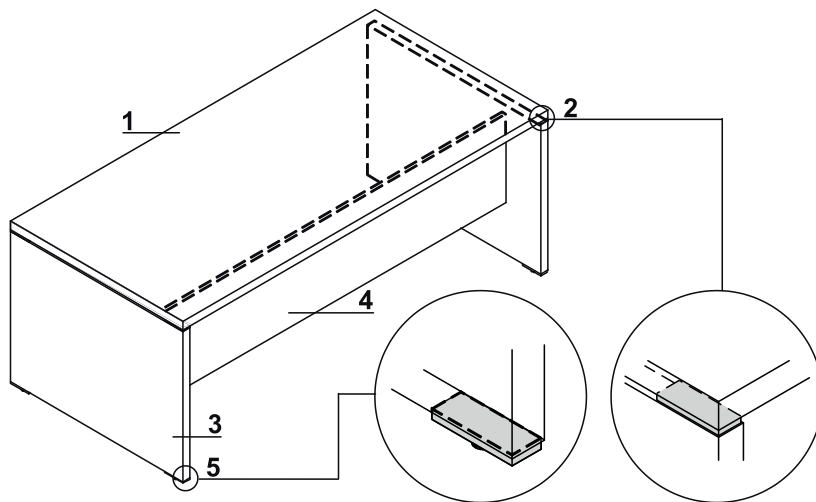

1. **Worktop** - MFC 38mm, PVC edge
2. **Top distance** - aluminum 100x34x9mm
3. **Base** - MFC 38mm, PVC edge
4. **Modesty panel** - MFC 18mm, PVC edge
5. **Leveling feet** - aluminum 100x34x9mm, range 5mm

POSSIBLE CONFIGURATIONS

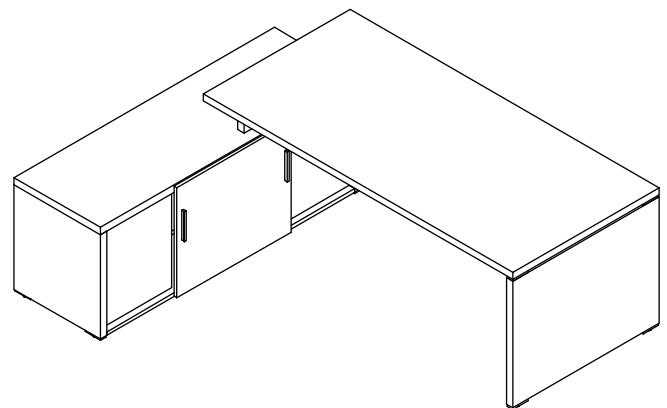
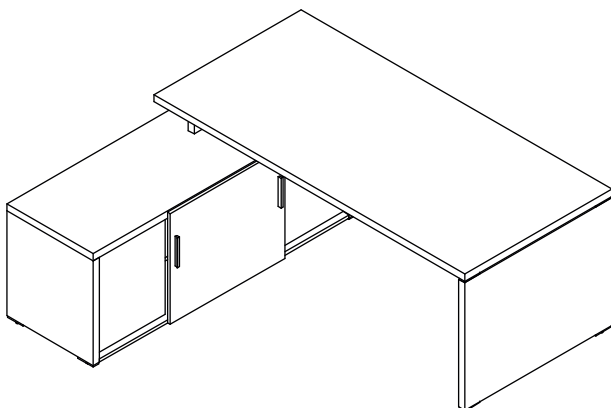

TECHNICAL SPECIFICATION

POSSIBLE CONFIGURATIONS

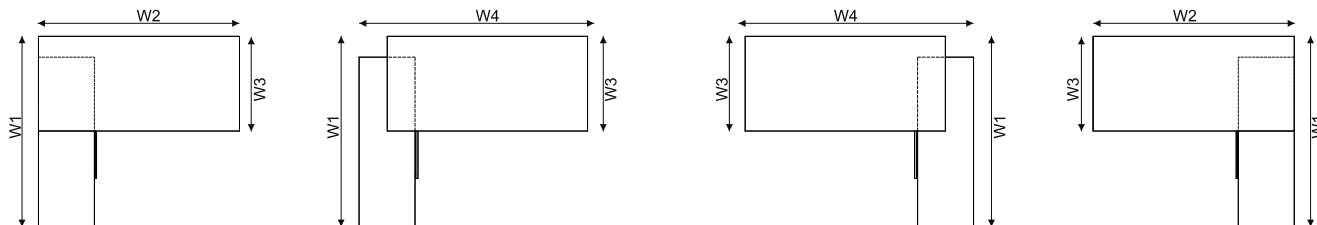

W1 - 1800mm | W2 - 1600mm/1900mm | W3 - 900mm | W4 - 1864/2164

CREDENZA

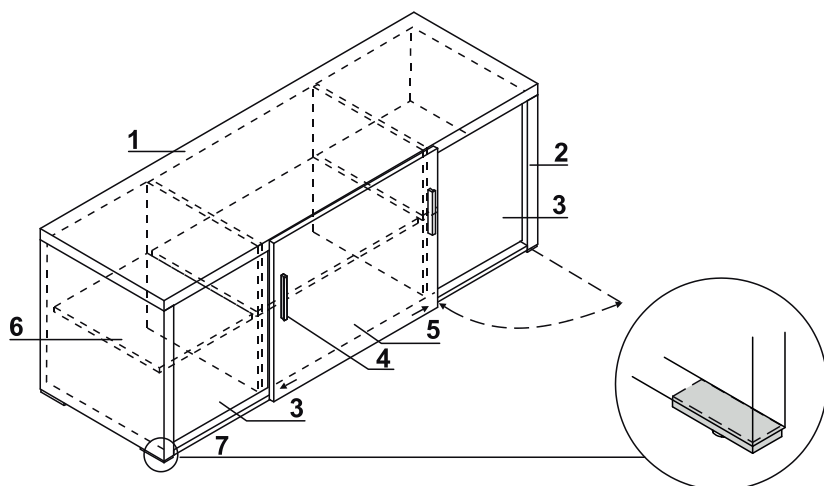

1. **Top** - MFC 38mm, PVC edge
2. **Side panels** - MFC 38mm, PVC edge
3. **Front** - MFC 18mm, PVC edge
4. **Aluminum handle**
5. **Sliding front** - MFC 18mm, PVC edge
6. **Shelf** - MFC 18mm, PVC edge
7. **Leveling feet** - aluminum 100x34x9mm, range 5mm

STORAGES

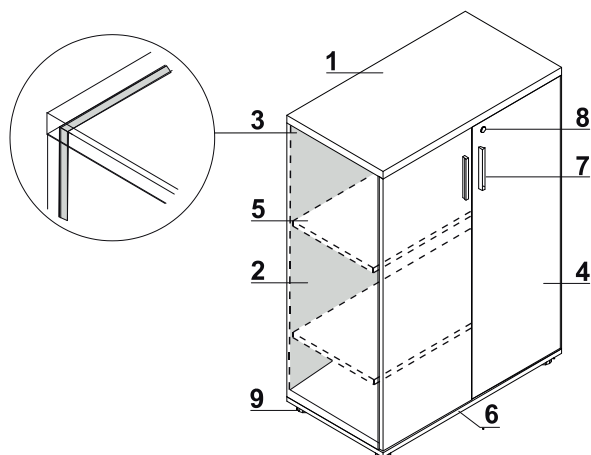

1. **Top** - MFC 28mm, PVC edge
2. **Side panels** - MFC 18mm, PVC edge
3. **Back MFC** - 18mm, PVC edges
4. **Front** - MFC 18 mm, PVC edges, plain hinge 110°
5. **Shelf** - MFC 18mm, PVC edge
6. **Base** - MFC 18mm, PVC edge
7. **Aluminum handle**
8. **Patent lock**
9. **Leveling feet** 27mm - range 12mm

TECHNICAL SPECIFICATION

STORAGE WITH SLIDING FRONT - Q315

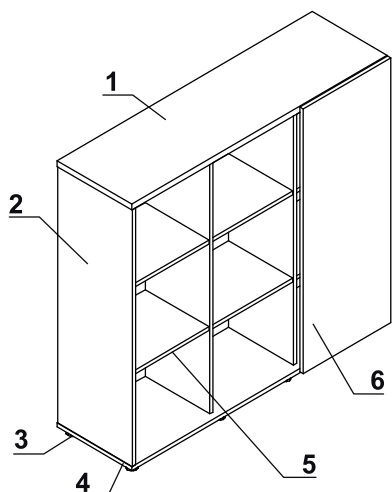

- 1. **Top** - MFC 28mm, PVC edge
- 2. **Side panels** - MFC 18mm, PVC edge
- 3. **Leveling feet 27mm** - range 12mm
- 4. **Base** - MFC 18mm, PVC edge
- 5. **Shelf** - MFC 18mm, PVC edge
- 6. **Sliding front** - MFC 18mm, PVC edge

OPTIONAL STORAGE TOPS

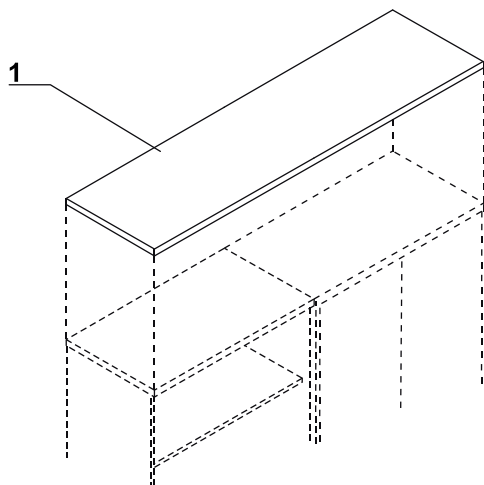

- 1. **Top** - MFC 38mm, PVC edge

ADDITIONAL ELEMENTS FOR STORAGE

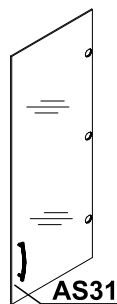
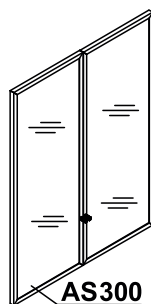
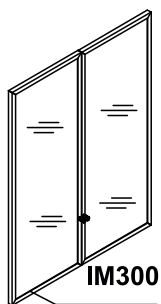

IM300

- glass door 30H
- transparent tempered glass 4mm, with aluminum frame

AS300

- glass door 30H
- frosted tempered glass 4mm, with aluminum frame

AS31

- glass door 30H
- transparent tempered glass 4mm
- universal (left,right)

TECHNICAL SPECIFICATION

MOBILE PEDESTAL QD13

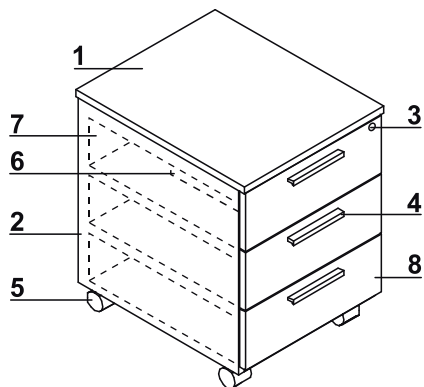

- 1. **Top** - MFC 18mm, PVC edge
- 2. **Body** - MFC 18mm, PVC edge
- 3. **Central lock** - foldable key
- 4. **Aluminum handle**
- 5. **Castors** - Ø50mm, two with brakes
- 6. **Pencil tray** - black plastic
- 7. **MFC drawer** - roll runners, max load 25kg, 80% extraction; Anti - tilt mechanism
- 8. **Front** - MFC 18mm,PVC edge

MFC BASE MEETING TABLES

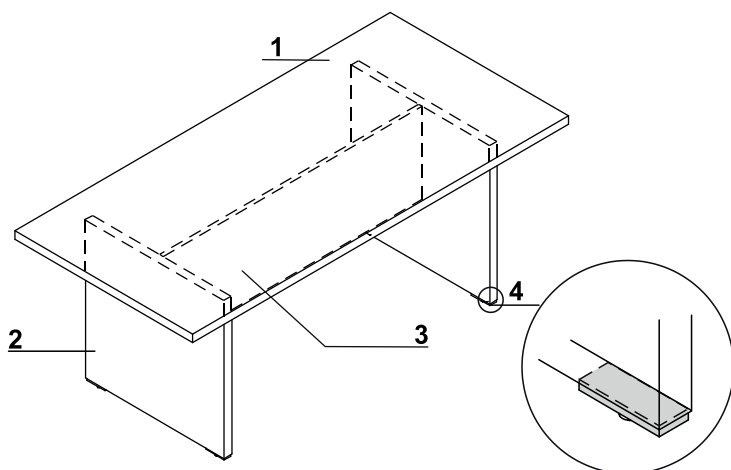

- 1. **Worktop** - MFC 38mm, PVC edge
- 2. **Base** - MFC 38mm, PVC edge
- 3. **Modesty panel** - MFC 18mm, PVC edge
- 4. **Leveling feet** - aluminum 100x34x9mm, range 5mm

DISC BASE MEETING TABLES

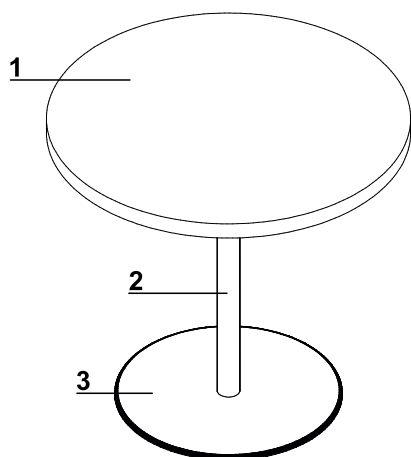

- 1. **Worktop** - MFC 38mm, PVC edge
- 2. **Column** - powder coated steel
- 3. **Disc** - stainless steel

TECHNICAL SPECIFICATION
MEDIABOX LOCATION

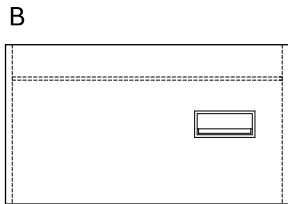
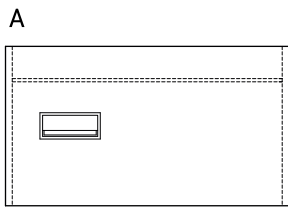

Q16, Q19

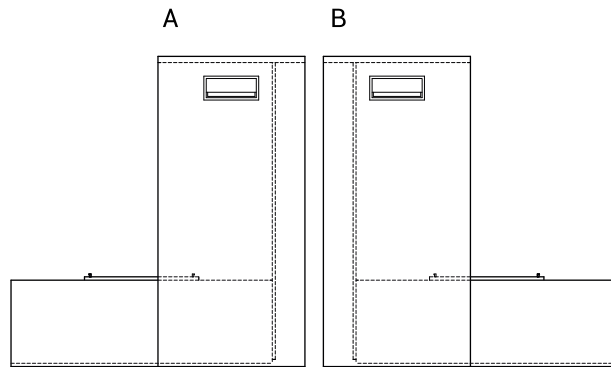

QU16, QU19

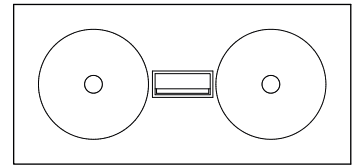

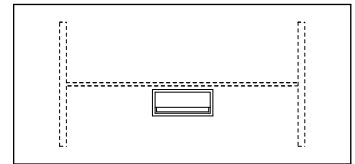

QS20



QS19

TO ORDER PRODUCT WITH MEDIABOX, AT THE END OF THE SYMBOL SHOULD BE ADDED A LETTER (A,B,...) WHICH IS CORRESPONDING TO THE SELECTED CONFIGURATION (EX. Q19A)

PRODUCT ILLUSTRATION	DIMENSIONS [mm]			INDEX SYMBOL						COMMENTS
	WIDTH	DEPTH	HEIGHT			kg	m3	pcs		

DESKS

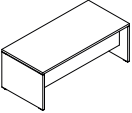
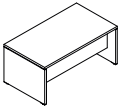
	1900	900	740	Q19		82.9	0.195	4		
	1600	900	740	Q16		73.0	0.168	4		

DESK EXTENSION

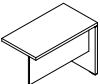
	1000	550	740	Q10		27.0	0.066	1		universal left or right
---	------	-----	-----	------------	--	------	-------	---	--	-------------------------

DESKS WITH MANAGERIAL SIDE STORAGE

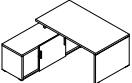
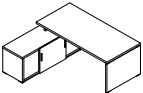
	1864 1600	1800 900	740	QU16		138.5	0.323	5		universal system left or right
	2164 1900	1800 900	740	QU19		148.4	0.351	5		universal system left or right

CREDENZA

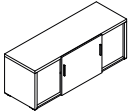
	1600	550	610	QR16		81.0	0.186	2		
---	------	-----	-----	-------------	--	------	-------	---	--	--

PEDESTAL



	402	600	590	QD13		30.0	0.142	1		
---	-----	-----	-----	-------------	--	------	-------	---	--	--

DESCRIPTION





 - NET WEIGHT

 VOLUME



 NUMBER OF PACKAGES

PRODUCT ILLUSTRATION	DIMENSIONS [mm]			INDEX SYMBOL						COMMENTS
	WIDTH	DEPTH	HEIGHT			kg	m3	pcs		

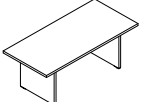
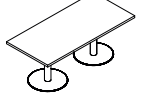
MEETING TABLES

	800	800	550	QSL08		30.0	0.077	2		
	800	800	740	QS08		36.0	0.089	2		
	800	800	740	QS09		35.0	0.113	3		
	1200	1200	740	QS12		60.0	0.165	3		
	1900	900	740	QS19		71.9	0.154	3		
	1900	900	740	QS20		100.9	0.240	5		

ADDITIONAL CHARGE



FEATURE	PRODUCT											COMMENTS
					QS19	QS20			kg	m3	pcs	
MEDIABOX M04H									0.1	0.0001	1	
MEDIABOX M04									0.9	0.0070	1	
TOP ACCESS M05									0.9	0.0070	1	

DESCRIPTION





 - NET WEIGHT

 VOLUME



 NUMBER OF PACKAGES

PRODUCT ILLUSTRATION	DIMENSIONS [mm]			INDEX SYMBOL						COMMENTS
	WIDTH	DEPTH	HEIGHT			kg	m3	pcs		

STORAGES

	801	432	1129	Q35		37.0	0.091	2		
	801	432	1129	Q31		43.0	0.116	3		
	1400	432	1280	Q315		72.0	0.187	3		sliding door
	801	432	1833	Q54		65.0	0.186	3		
	801	432	1833	Q51		75.0	0.213	3		

OPTIONAL STORAGE TOPS



	806	434	38	QT08		8.5	0.023	1		
	1608	434	38	QT16		17.0	0.044	1		
	2410	434	38	QT24		26.0	0.066	1		

DESCRIPTION







 - NET WEIGHT

 VOLUME

 NUMBER OF PACKAGES

PRODUCT ILLUSTRATION	DIMENSIONS [mm]			INDEX SYMBOL						COMMENTS
	WIDTH	DEPTH	HEIGHT			kg	m3	pcs		

ADDITIONAL ELEMENTS

	397	5	1050	AS31		6.5	0.034	1		universal glass door (1pcs) 3OH, transparent tempered glass
	800	20	1050	AS300		10.3	0.037	1		glass doors (2pcs) 3OH aluminum frame, frosted tempered glass
	800	20	1050	IM300		10.0	0.039	1		glass doors (2pcs) 3OH aluminum frame, transparent tempered glass
	12	17	158	HQ2		0.1	0.000	1		handles QUANDO (2 psc)
	275	120	140	M04		0.0	0.001	0		4x230V, 2xRJ45, 1xUSB
	275	120	140	M04H		0.0	0.001	0		4x230V, 2xRJ45, 1xUSB, 1xHDMI
	275	120	25	M05		0.3	0.002	1		TOP ACCESS

DESCRIPTION

 - NET WEIGHT

 VOLUME

 NUMBER OF PACKAGES