

TECHNICAL SPECIFICATION

COLOURS

COUNTER TOP - GLASS



WHITE, LACOBEL

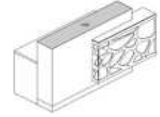

BODY



67 WHITE PASTEL

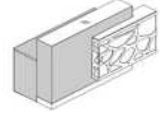

FRONT - METAL



M015 WHITE
SEMI-MATTE

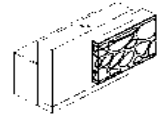

FRONT - PLEXIGLASS



PLEXIGLASS
WHITE

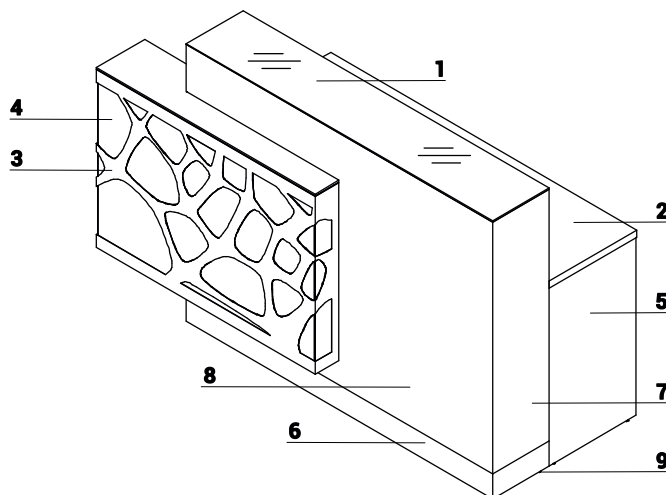
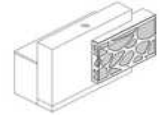

1. **Glass top** - glass LACOBEL 4mm
2. **Worktop** - MFC 28mm, PVC edge
3. **Front** - powder coated steel and plexiglas
4. **Light source** - RGBW LED, remote control
5. **Low side panel** - MFC 28mm, PVC edge
6. **Kick plate** - HPL - brushed aluminum
7. **Body** - MFC 18mm+ HPL - mat
8. **Front** - MFC 28mm + HPL - mat 0,8mm, PVC edge
9. **Leveling** - 5mm range

TECHNICAL SPECIFICATION

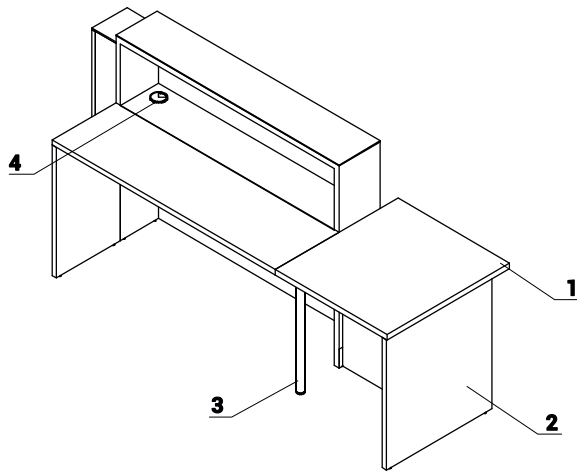

- 1. **Worktop** - MFC 28mm, PVC edge
- 2. **Low side panel** - MFC 28mm, PVC edge
- 3. **Supporting leg NE41**- required for connecting the tops
- 4. **Cable grommets** - Ø80mm

DIMENSIONS

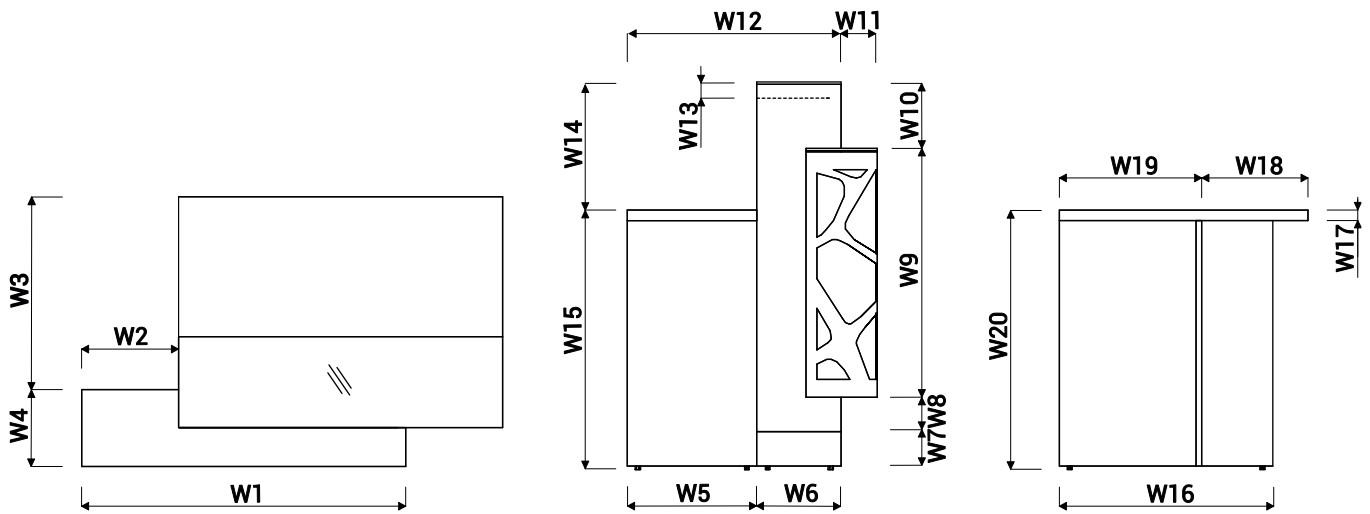

W1 - 1000mm | W2 - 300mm | W3 - 550mm | W4 - 222mm | W5 - 400mm | W6 - 260mm | W7 - 100mm | W8 - 97mm | W9 - 705mm | W10 - 184mm | W11 - 110mm | W12 - 660mm | W13 - 34mm | W14 - 365mm | W15 - 740mm | W16 - 660mm | W17 - 28mm | W18 - 318mm | W19 - 452mm | W20 - 740mm

RECEPTION DESKS SYSTEMS

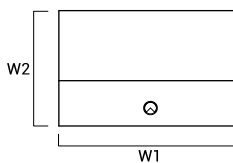
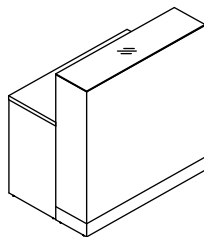

INDEX SYMBOL	DIMENSIONS [mm]						kg	m3	pcs	COMPONENTS
	W ₁	W ₂	D ₁	D ₂	H					
LOG10G	1000	660			1105		50.0	0.582	2	LOG10B+LOG10K
LOG14G	1400	660			1105		55.0	0.815	2	LOG14B+LOG14K

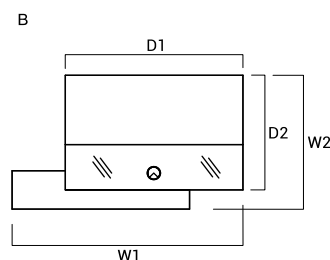
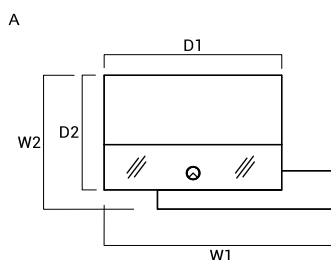
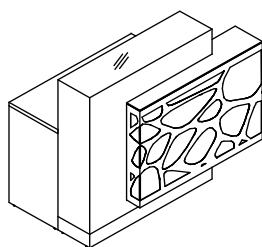

INDEX SYMBOL	DIMENSIONS [mm]						kg	m3	pcs	COMPONENTS
	W ₁	W ₂	D ₁	D ₂	H					
A LOG11LG	1300	770	1000	660	1105		75.5	0.740	4	LOG10B+LOG10K+LOG01L
B LOG11PG	1300	770	1000	660	1105		75.5	0.740	4	LOG10B+LOG10K+LOG01P

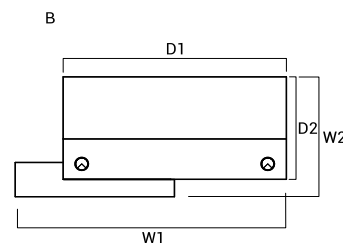
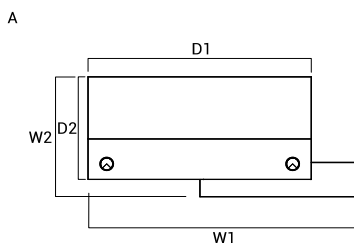
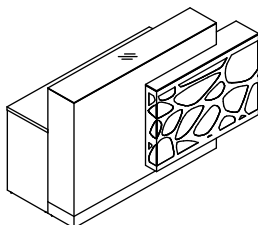

INDEX SYMBOL	DIMENSIONS [mm]						kg	m3	pcs	COMPONENTS
	W ₁	W ₂	D ₁	D ₂	H					
A LOG12LG	1700	770	1400	660	1105		80.5	0.973	4	LOG14B+LOG14K+LOG01L
B LOG12PG	1700	770	1400	660	1105		80.5	0.973	4	LOG14B+LOG14K+LOG01P

DESCRIPTION

- NET WEIGHT

VOLUME

NUMBER OF PACKAGES

RECEPTION DESKS SYSTEMS

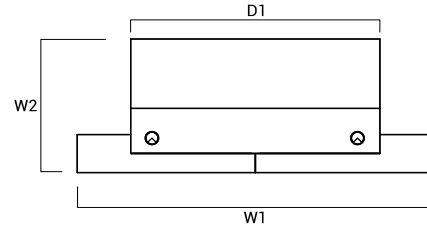
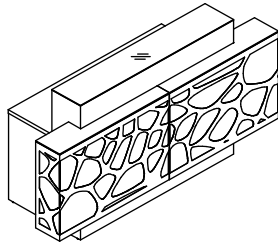

INDEX SYMBOL	DIMENSIONS [mm]						kg	m3	pcs	COMPONENTS
	W ₁	W ₂	D ₁	D ₂	H					
LOG13G	2000	770	1400	-	1105		106.0	1.132	6	LOG14B+LOG14K+LOG01L+LOG01P

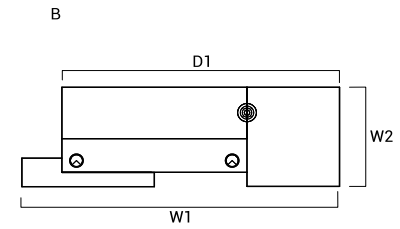
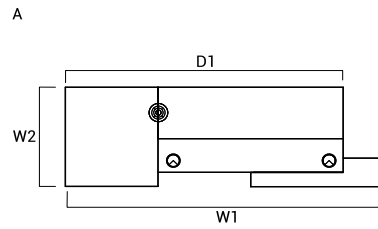
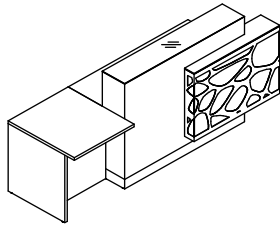

INDEX SYMBOL	DIMENSIONS [mm]						kg	m3	pcs	COMPONENTS
	W ₁	W ₂	D ₁	D ₂	H					
A LOG14PLG	2400	770	2100	-	1105		93.8	1.007	6	LOG01L+LOG14K+LOG14B+LOG07+NE41L
B LOG14PPG	2400	770	2100	-	1105		93.8	1.007	6	LOG07+LOG14B+LOG14K+LOG01P+NE41L

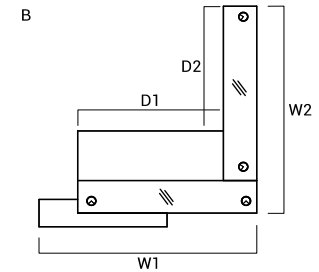
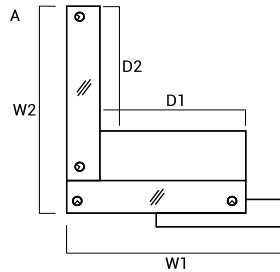
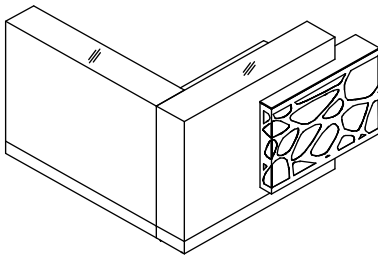

INDEX SYMBOL	DIMENSIONS [mm]						kg	m3	pcs	COMPONENTS
	W ₁	W ₂	D ₁	D ₂	H					
A LOG16LG	1700	1660	1140	1000	1105		120.5	1.297	5	LOG01L+2xLOG14K+LOG11B
B LOG16PG	1700	1770	-	-	1105		120.5	1.297	5	2xLOG14K+LOG11B+LOG01P

DESCRIPTION

- NET WEIGHT

VOLUME

NUMBER OF PACKAGES

RECEPTION DESKS SYSTEMS

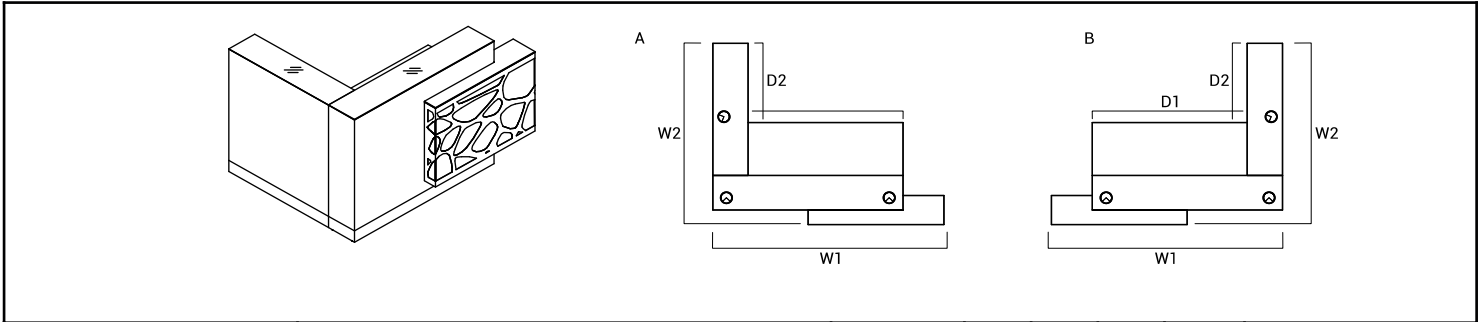

INDEX SYMBOL	DIMENSIONS [mm]						kg	m3	pcs	COMPONENTS
	W ₁	W ₂	D ₁	D ₂	H					
A LOG18LG	1700	1370	1140	600	1105		115.5	1.182	5	LOG01L+LOG14K+LOG11B+LOG10K
B LOG18PG	1700	1370			1105		115.5	1.182	5	LOG10K+LOG11B+LOG14K+LOG01P

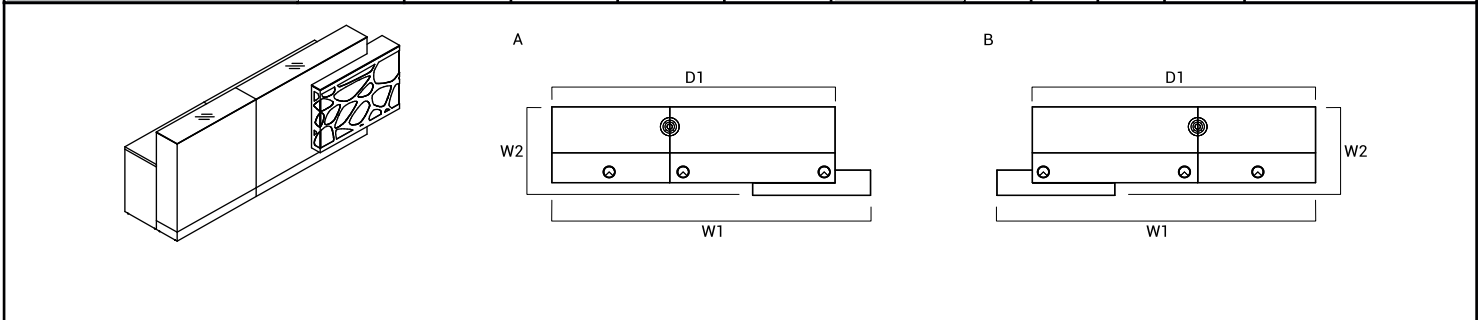

INDEX SYMBOL	DIMENSIONS [mm]						kg	m3	pcs	COMPONENTS
	W ₁	W ₂	D ₁	D ₂	H					
A LOG19LG	2700	770	2400	-	1105		131.8	1.557	7	LOG01L+LOG14K+LOG10K+LOG14B+LOG10B+NE41L
B LOG19PG	2700	770	2400	-	1105		131.8	1.557	7	LOG10B+LOG14B+LOG10K+LOG14K+LOG01P+NE41L

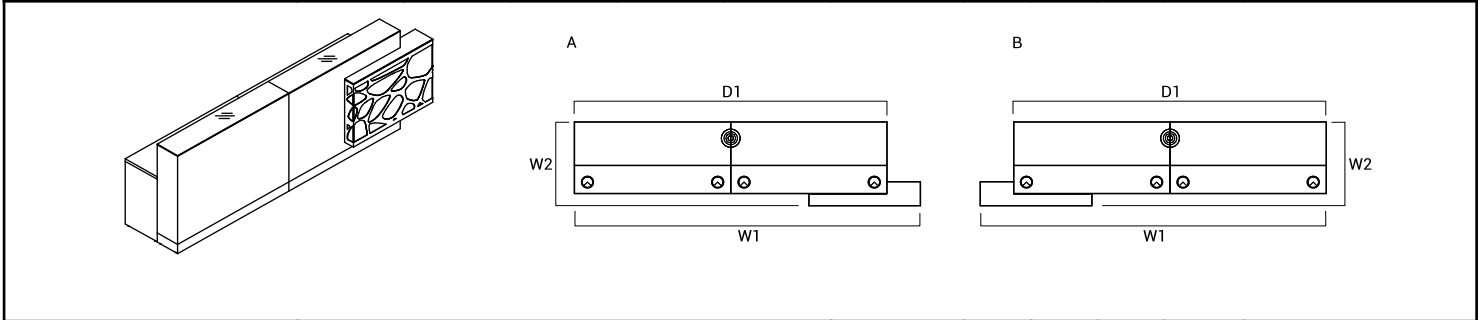

INDEX SYMBOL	DIMENSIONS [mm]						kg	m3	pcs	COMPONENTS
	W ₁	W ₂	D ₁	D ₂	H					
A LOG20LG	3100	770	2800	-	1105		136.8	1.790	7	LOG01L+2xLOG14K+2xLOG14B+NE41L
B LOG20PG	3100	770	2800	-	1105		136.8	1.790	7	2xLOG14B+2xLOG14K+LOG01P+NE41L

DESCRIPTION

- NET WEIGHT

VOLUME

NUMBER OF PACKAGES

RECEPTION DESKS SYSTEMS

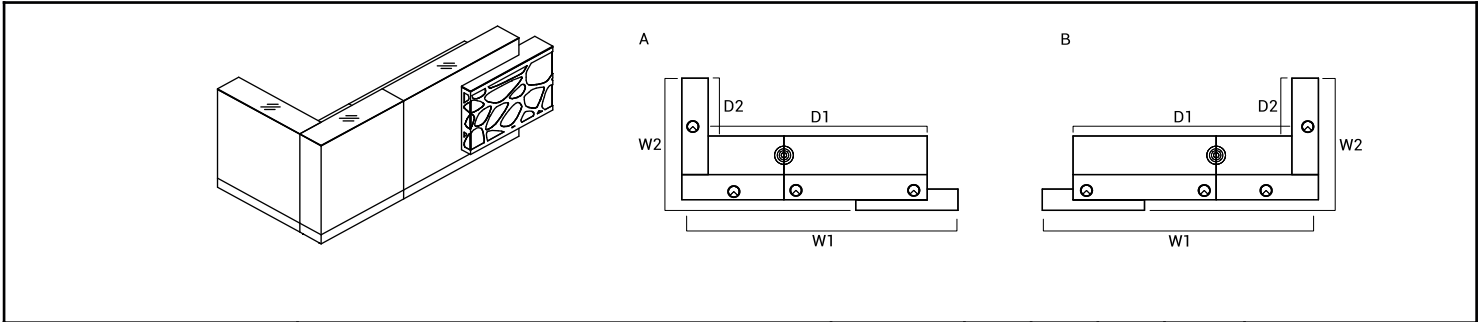

INDEX SYMBOL	DIMENSIONS [mm]					kg	m3	pcs	COMPONENTS
	W ₁	W ₂	D ₁	D ₂	H				
A LOG21LG	2700	1370	2140	600	1105	162.8	1.555	8	LOG01L+LOG14K+2xLOG10K+LOG14B+LOG08B+NE41L
B LOG21PG	2700	1370	2140	600	1105	162.8	1.555	8	2xLOG10K+LOG08B+LOG14B+LOG14K+LOG01P+NE41L

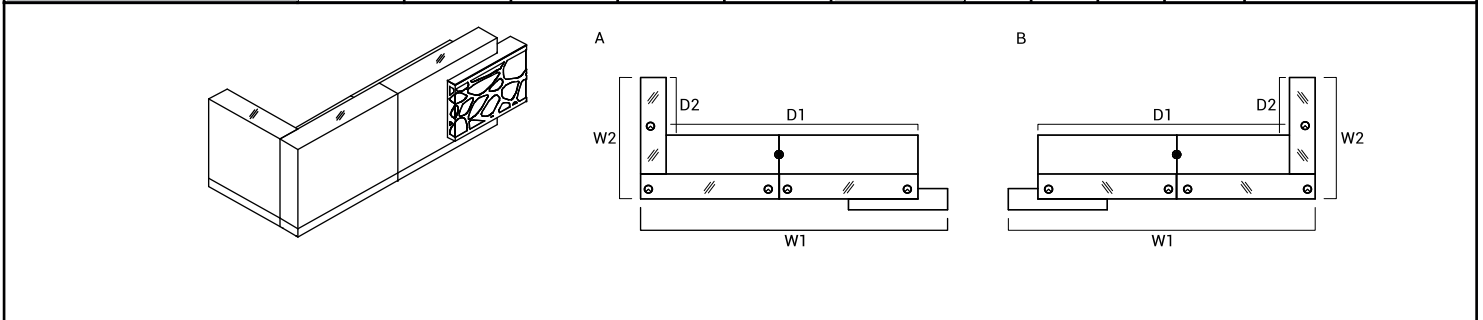

INDEX SYMBOL	DIMENSIONS [mm]					kg	m3	pcs	COMPONENTS
	W ₁	W ₂	D ₁	D ₂	H				
A LOG22LG	3100	1370	2540	600	1105	171.8	1.999	8	LOG01L+2xLOG14K+LOG14B+LOG11B+LOG10K+NE41L
B LOG22PG	3100	1370	2540	600	1105	171.8	1.999	8	LOG10K+LOG11B+LOG14B+2xLOG14K+LOG01P+NE41L

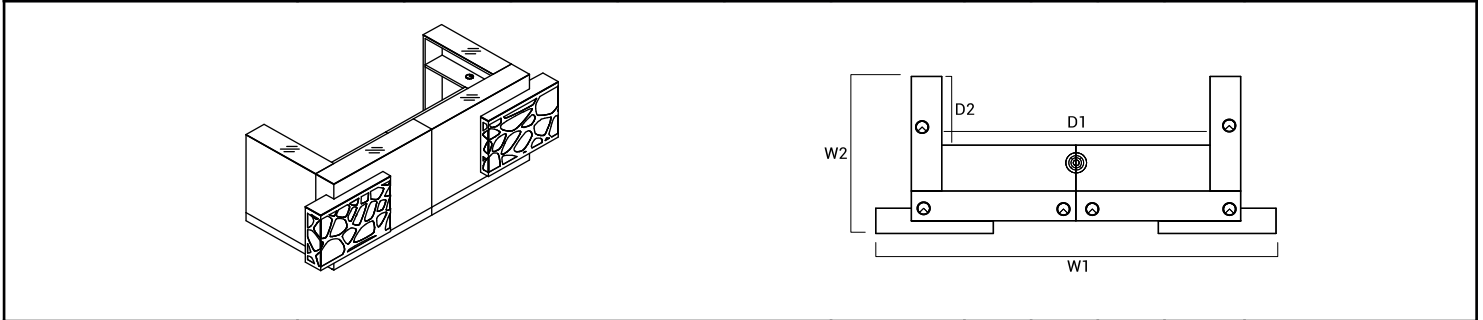

INDEX SYMBOL	DIMENSIONS [mm]					kg	m3	pcs	COMPONENTS
	W ₁	W ₂	D ₁	D ₂	H				
LOG23G	3400	1370	2280	600	1105	232.3	2.366	11	2xLOG10K+2xLOG11B+2xLOG14K+LOG01L+LOG01P+NE41L

DESCRIPTION

- NET WEIGHT

VOLUME

NUMBER OF PACKAGES

RECEPTION DESKS SYSTEMS

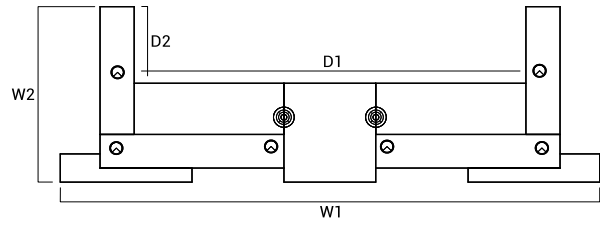
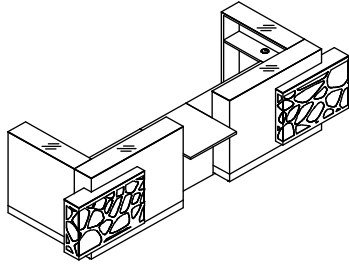

INDEX SYMBOL	DIMENSIONS [mm]						kg	m3	pcs		COMPONENTS
	W ₁	W ₂	D ₁	D ₂	H						
LOG24G	4100	1370			1105		245.6	2.401	13		2xLOG10K+2xLOG14K+2xLOG11B +LOG07+LOG01L+LOG01P +2xNE41L

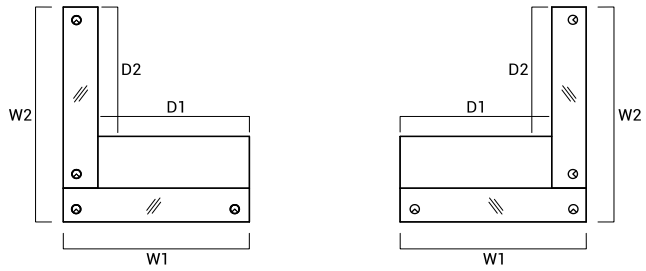
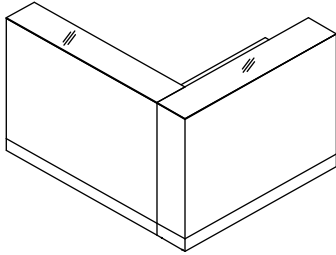

INDEX SYMBOL	DIMENSIONS [mm]						kg	m3	pcs		COMPONENTS
	W ₁	W ₂	D ₁	D ₂	H						
LOG15	1400	1660			1105		95.0	1.138	3		2xLOG14K+LOG11B

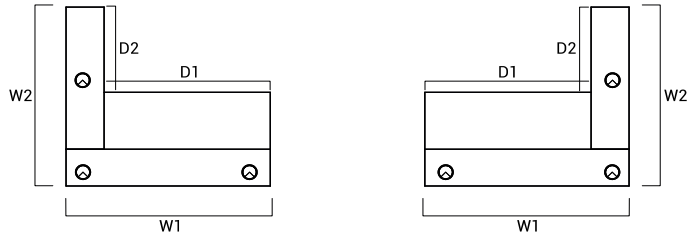
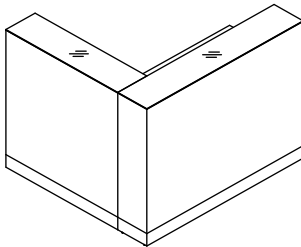

INDEX SYMBOL	DIMENSIONS [mm]						kg	m3	pcs		COMPONENTS
	W ₁	W ₂	D ₁	D ₂	H						
LOG17	1400	1260			1105		90.0	1.024	3		LOG11B+LOG14K+LOG10K

DESCRIPTION

- NET WEIGHT

VOLUME

NUMBER OF PACKAGES

RECEPTION DESKS SYSTEMS

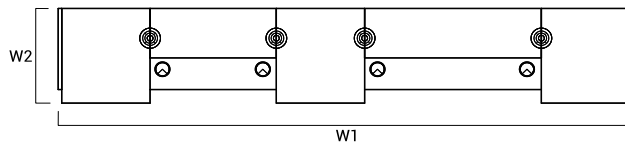
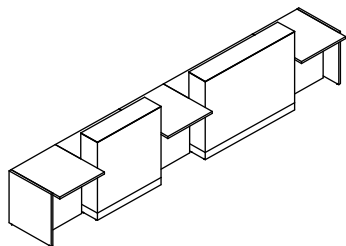



INDEX SYMBOL	DIMENSIONS [mm]									COMPONENTS
	W ₁	W ₂	D ₁	D ₂	H		kg	m ³	pcs	
LOG25	4556	770			1105		146.2	1.501	11	3xLOG07+LOG14B+LOG14K +LOG10B+LOG10K+4xNE41L

DESCRIPTION







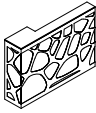
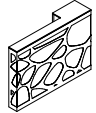

- NET WEIGHT

VOLUME

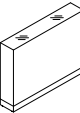
NUMBER OF PACKAGES

PRODUCT ILLUSTRATION	DIMENSIONS [mm]			INDEX SYMBOL						COMMENTS
	WIDTH	DEPTH	HEIGHT			kg	m3	pcs		

COMPOSITION ELEMENTS

	728	770	740	LOG07		13.3	0.034	2		universal element
	1000	220	710	LOG01P		25.5	0.158	2		right
	1000	220	710	LOG01L		25.5	0.158	2		left
	1000	260	1105	LOG10K		35.0	0.286	1		
	1400	260	1105	LOG14K		40.0	0.400	1		
	740	400	28	LOG08B		11.0	0.008	1		
	1000	400	740	LOG10B		15.0	0.296	1		
	1140	400	740	LOG11B		15.0	0.337	1		
	1400	400	740	LOG14B		15.0	0.414	1		
	40	40	712	NE41L		1.5	0.002	1		round profile leg

DESCRIPTION

 - NET WEIGHT

 VOLUME

 NUMBER OF PACKAGES