

TECHNICAL SPECIFICATION

COLOURS

DESKS, CONFERENCE TABLES - WORKTOP



111 LIGHT
SYCAMORE



112 DARK
SECAMORE

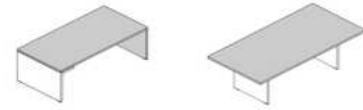

DESKS, CONFERENCE TABLES - BASE HPL



73 HIGH GLOSS
WHITE



101 HIGH GLOSS
BLACK

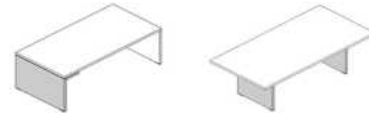

COLUMN COLOUR



M115 BLACK
SEMI-MATTE



M009 ALUMINUM
SEMI-MATTE



M015 WHITE
SEMI-MATTE



MODULAR TABLES MIT06, MIT07, MIT08



111 LIGHT
SYCAMORE



112 DARK
SECAMORE



MANAGERIAL STORAGE, PEDESTAL, MOBILE PEDESTAL MIT130



111 LIGHT
SYCAMORE



112 DARK
SECAMORE

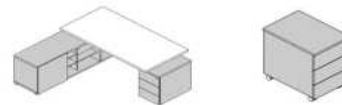

MANAGERIAL STORAGE EXTENSION MIT5



73 HIGH GLOSS
WHITE



101 HIGH GLOSS
BLACK



STORAGE - BODY



111 LIGHT
SYCAMORE



112 DARK
SECAMORE



STORAGE - FRONT (MIT8 , MIT15)



111 LIGHT
SYCAMORE



112 DARK
SECAMORE



STORAGE - FRONT HPL (MIT7 , MIT18, MIT19, MIT20, MIT21, MIT22)

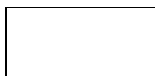

73 HIGH GLOSS
WHITE



101 HIGH GLOSS
BLACK



TECHNICAL SPECIFICATION

COLOURS

MOBILE PEDESTAL SLD

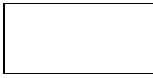

67 WHITE PASTEL

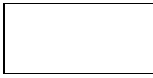

73 HIGH GLOSS WHITE



08 BLACK



101 HIGH GLOSS BLACK



CUSHION SKP13 - FABRIC NEMO



NE-1 BEIGE



NE-2 YELLOW



NE-3 ORANGE



NE-5 RED



NE-9 GREEN

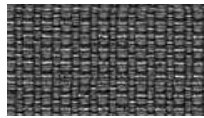

NE-10 GREY



NE-14 DARK GREY



NE-15 NAVY BLUE



NE-16 BLACK



NE-17 BLUE

CUSHION SKP13 - FABRIC RUNNER - SECOND GROUP



R-63034 ORANGE



R-64089 RED



R-66063 BLUE



R-60011 GREY



R-68056 GREEN

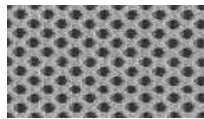

R-66064 NAVY-BLUE



R-60999 BLACK



R-60025 DARK GREY



R-61128 BEIGE

CUSHION SKP13 - FABRIC MEDLEY - SECOND GROUP



M-68005 DARK OLIVE



M-68002 LIGHT OLIVE



M-68115 GREEN



M-61002 BEIGE



M-67053 NAVY BLUE



M-67006 LIGHT BLUE



M-66008 GREY



M-64019 RED



M-63064 PINK



M-60999 BLACK

CUSHION SKP13 - FABRIC ATLANTIC - SECOND GROUP



A-67043 DARK TURQUOISE



A-67030 SEA-GREEN



A-60141 LIGHT GREY



A-60011 GREY



A-66064 NAVY BLUE



A-65037 VIOLET



A-62048 OLIVE



A-64089 RED



A-61078 BEIGE



A-60025 GRAPHITE

TECHNICAL SPECIFICATION

COLOURS

CUSHION SKP13 - FABRIC BLAZER - THIRD PRICE GROUP

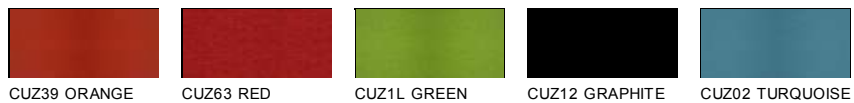

CUZ1R - SEA-GREEN



CUSHION SKP13 - FABRIC XTREME - THIRD PRICE GROUP



TECHNICAL SPECIFICATION

DESKS

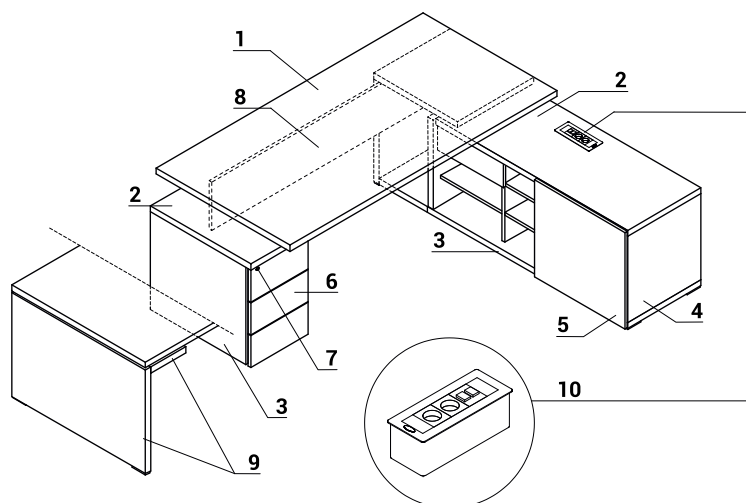

- 1. **Worktop** - MFC 38mm, PVC edge
- 2. **Top** - MFC 38mm, PVC edge
- 3. **Base** - MFC 38mm, PVC edge
- 4. **Body** - MFC 18mm, PVC edge
- 5. **Sliding front** - MFC 18mm, PVC edge
- 6. **Front** - MFC 18mm,PVC edge
- 7. **Central lock** - foldable key
- 8. **Modesty panel** - MFC 18mm, PVC edge
- 9. **HPL base** - high gloss - 38mm
- 10. **Option with additional charge Mediaport S91E** - 2x230V, 2xRJ45

POSSIBLE CONFIGURATIONS

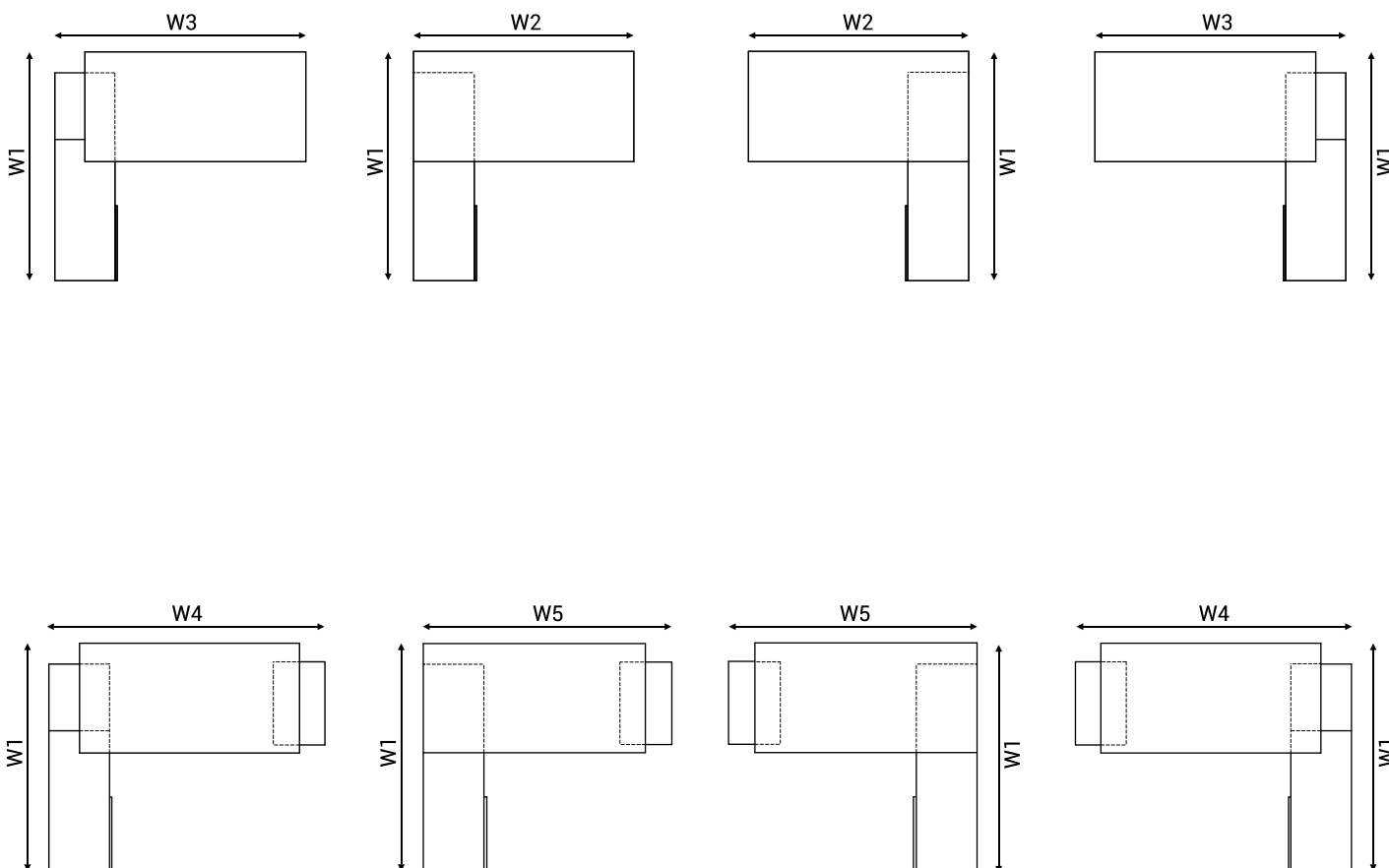

W1 - 2080mm | W2 - 1800/2000 mm | W3 - 2078/2278 mm | W4 - 2297/2497mm | W5 - 2019/2219 mm

TECHNICAL SPECIFICATION

DESK WITH ELECTRIC ADJUSTMENT

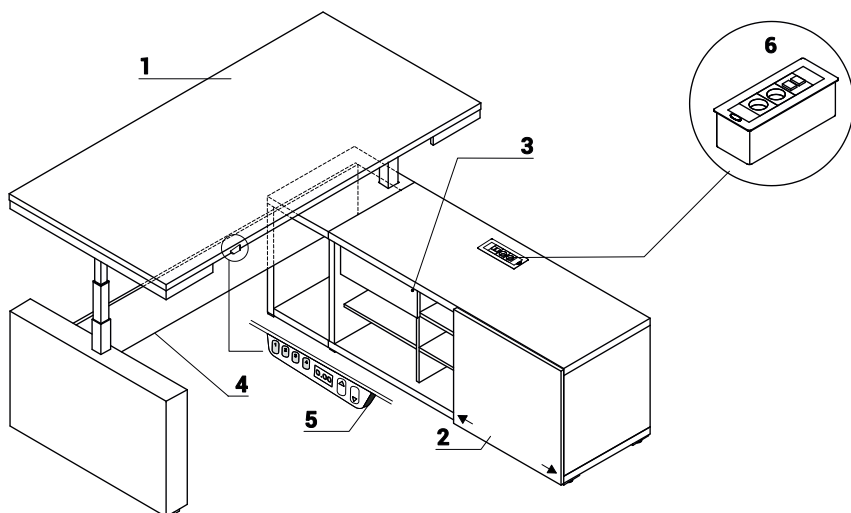

1. **Worktop** - MFC 38mm, PVC edge
2. **Sliding front** - MFC 18mm, PVC edge
3. **Drawer** - MFC 18mm, PVC edge, possible different position
4. **Electric height adjustable base** - powder coated steel, load 100kg, telescopic leg 60/60, 50/50, 40/40mm
5. **Control panel**
6. **Option with additional charge Mediaport S91E** - 2x230V, 2xRJ45
7. **Cable grommets**

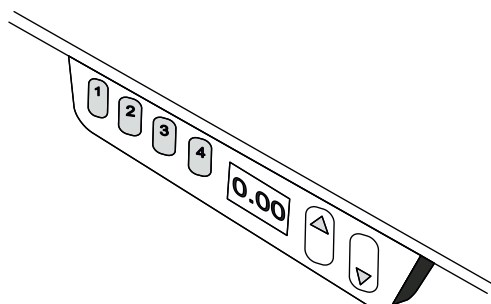
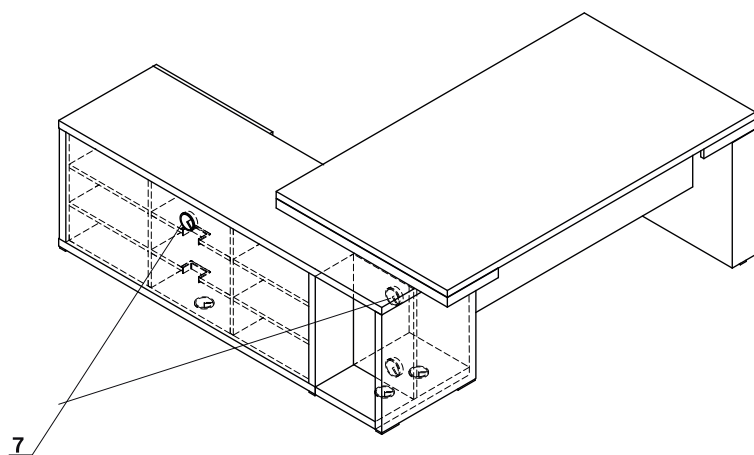

FRAME TECHNICAL SPECIFICATION

Height adjustment - 40mm/sec Super Soft Start - Stop

Drive - 2 synchronised motors with microprocessor, work control sensor

ISP - Intelligent System Protection

Norms - ISO 21016, EN 527-2, EN 527 -3

EU Directives - 206/95EC, UI508 1999, UL 1004 R7 06, WE DC 2004/108WE

Power supply - 230V, 300W, power consumption on

Standby - 0.3W

TECHNICAL SPECIFICATION

POSSIBLE CONFIGURATIONS

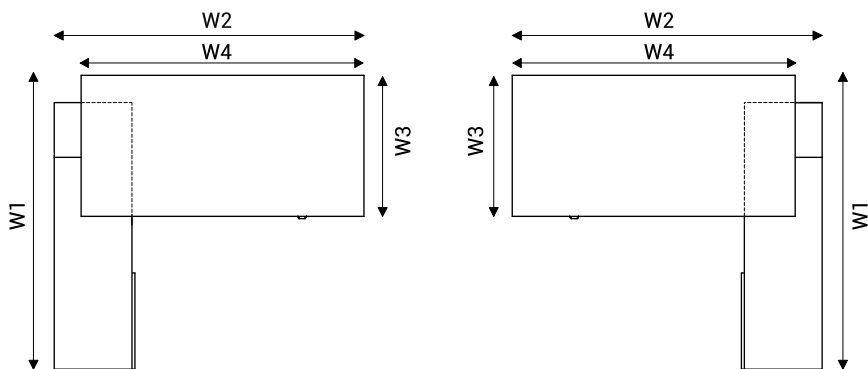

W1 - 2080 mm | W2 - 1990/2190 mm | W3 - 1000 mm | W4 - 1800/2000mm

MANAGERIAL STORAGE

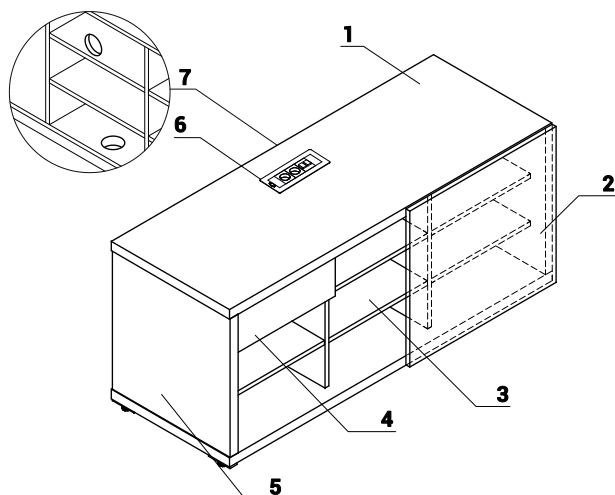

- 1. **Top** - MFC 38mm, PVC edge
- 2. **Front** - MFC 18mm, PVC edge
- 3. **Interior** - MFC 18mm
- 4. **Drawer** - MFC 18mm, PVC edge, lock - possible to change location
- 5. **Side panels** - MFC 38mm, PVC edge
- 6. **Option with additional charge Mediaport S91E** - 2x230V, 2xRJ45
- 7. **Cable grommets** - Ø80mm

DISC BASE MEETING TABLES

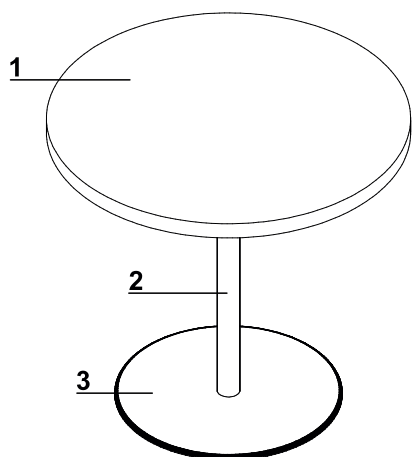

- 1. **Worktop** - MFC 38mm, PVC edge
- 2. **Column** - powder coated steel
- 3. **Disc** - stainless steel

TECHNICAL SPECIFICATION

MFC BASE MEETING TABLES

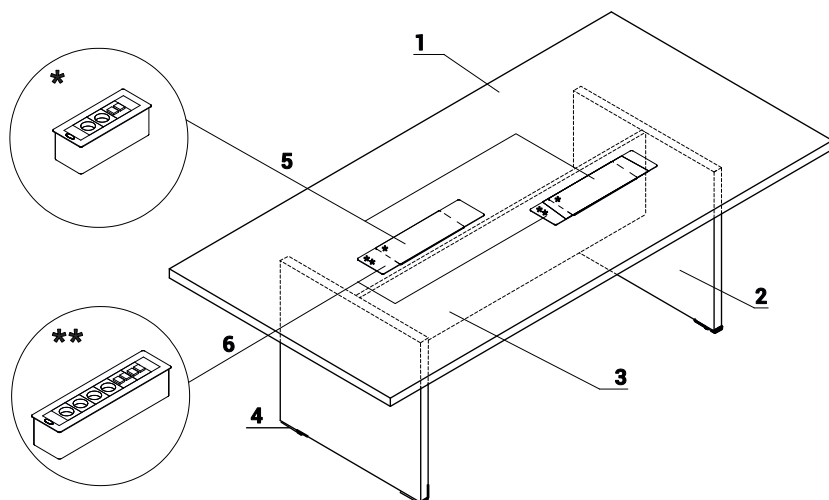

1. **Worktop** - MFC 38mm, PVC edge
2. **HPL base** - high gloss - 38mm
3. **Modesty panel** - MFC 18mm, PVC edge
4. **Leveling** - 5mm range
5. **Option with additional charge Mediaport S91E** - 2x230V, 2xRJ45
6. **Option with additional charge Mediaport S92E** - 4x230V, 4xRJ45

ATTENTION: For tables MIT06, MIT07, MIT08 conference tables with mediaboxes can be ordered as option. To order add a letter at the end of a product index: Mediabox S91E : Locations A,B (1pcs – extra charge 330,-), or C (2pcs – extra charge 660,-) | - Mediaport S92E: Locations G,H (1pcs - 500,-), or K (2pcs - 1000,-)

STORAGES

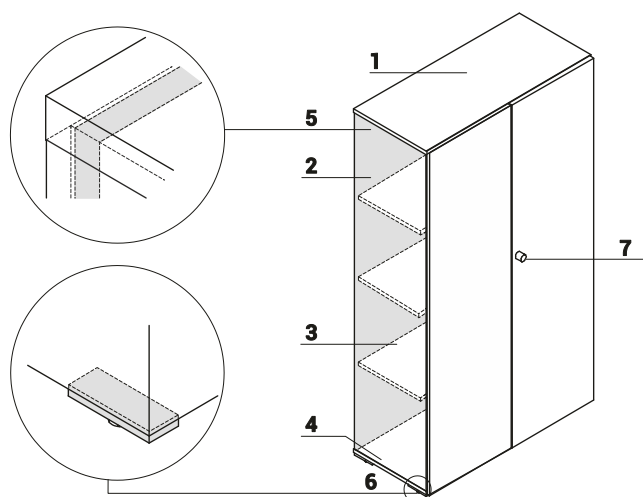

1. **Top** - MFC 18mm, PVC edge
2. **Side panels** - MFC 18mm, PVC edge
3. **Shelf** - MFC 18mm, PVC edge
4. **Base** - MFC 18mm, PVC edge
5. **Back MFC** - 18mm, PVC edges
6. **Leveling** - 5mm range
7. **Espagnolette lock in doorknob**

SLIDING DOOR STORAGES

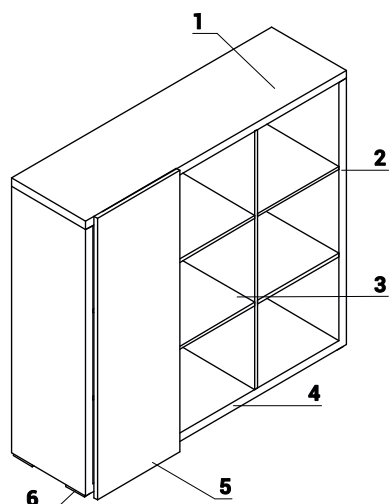

1. **Top** - MFC 38mm, PVC edge
2. **Side panels** - MFC 38mm, PVC edge
3. **Interior** - MFC 18mm
4. **Base** - MFC 38mm, PVC edge
5. **Sliding front** - MFC 18mm, PVC edge
6. **Leveling** - 5mm range

Sliding front storages MIT7 / MIT18

TECHNICAL SPECIFICATION

SUSPENSION FILES STORAGE

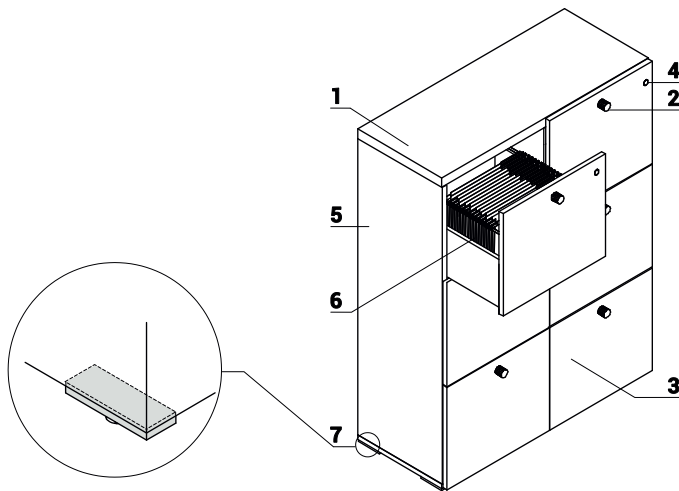

1. **Top** - MFC 38mm, PVC edge
2. **Aluminum handle**
3. **Front** - HPL - high gloss
4. **Central lock** - foldable key
5. **Side panels** - MFC 18mm, PVC edge
6. **Suspension files drawer** - MFC 18mm, ball runners, max load 45kg, 100% extraction
7. **Leveling** - 5mm range

MOBILE PEDESTAL MIT130

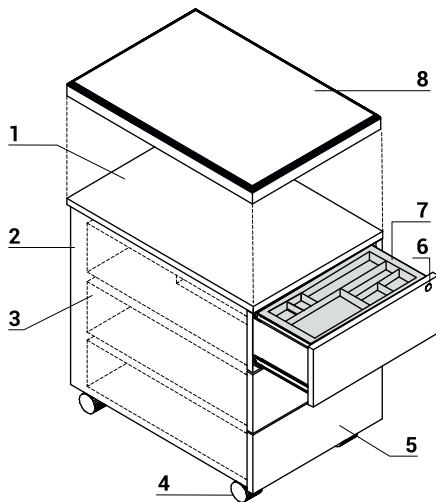

1. **Top** - MFC 18mm, PVC edge
2. **Body** - MFC 18mm, PVC edge
3. **MFC drawer** - ball runners, max load 25kg, 100% extraction; Anti - tilt mechanism, soft closing
4. **Castors** - Ø50mm, two with brakes
5. **Front** - MFC 18mm, PVC edge
6. **Central lock** - foldable key
7. **Pencil tray** - black plastic
8. **Cushion SKP13** - for pedstal, order separately, max load 120kg

ATTENTION - no sitting on pedestals without castors support; to be ordered with cushion SKP13

MOBILE PEDESTAL WITHOUT HANDLES

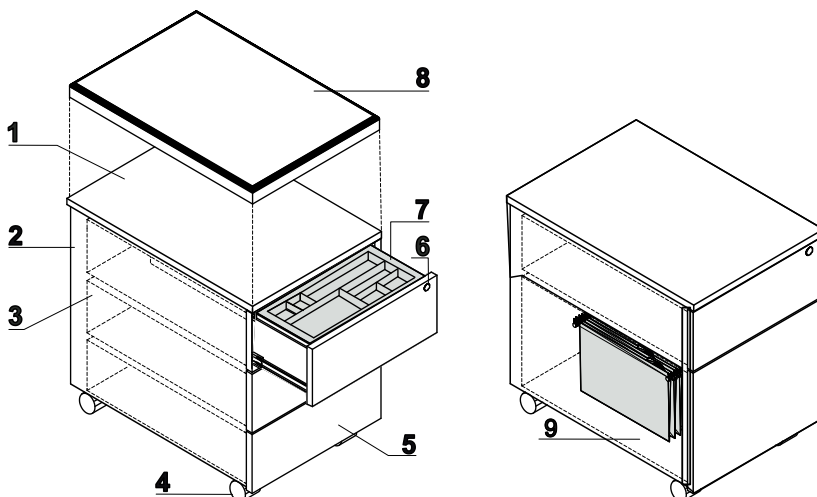



1. **Top** - MFC 18mm, covered with high gloss HPL
2. **Body** - MFC 18mm, PVC edge
3. **Metal drawer** - roll runners, max load 25kg, 80% extraction; Anti - tilt mechanism; OPTIONAL: ball runners, soft closing
4. **Castors** - Ø50mm, two with brakes
5. **Front** - HPL 18mm - high gloss, PVC edge
6. **Central lock** - foldable key
7. **Pencil tray** - black plastic
8. **Cushion SKP13** - for pedstal, order separately, max load 120kg
9. **Suspension files drawer** - ball runners, max load 30kg, 100% extraction, A4 folders must be inserted parallelly to the front

ATTENTION - no sitting on pedestals without castors support; to be ordered with cushion SKP13

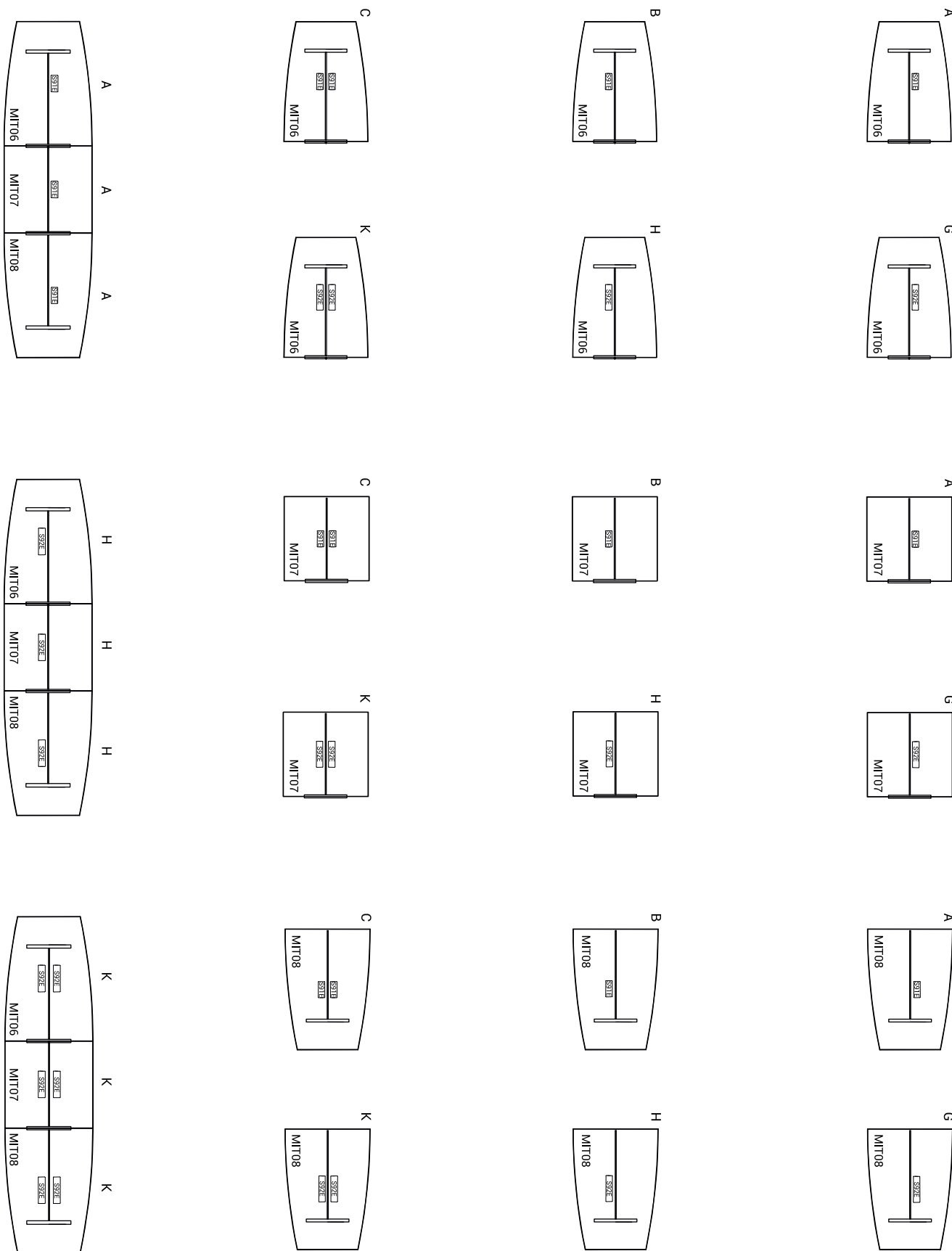
POSSIBLE MEDIAPORT LOCATION



TO ORDER PRODUCT WITH MEDIABOX, AT THE END OF THE SYMBOL SHOULD BE ADDED A LETTER (A,B,...) WHICH IS CORRESPONDING TO THE SELECTED CONFIGURATION (EX. X01A)

PRODUCT ILLUSTRATION	DIMENSIONS [mm]			INDEX SYMBOL						COMMENTS
	WIDTH	DEPTH	HEIGHT			kg	m3	pcs		

DESKS

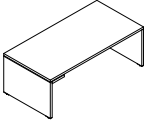
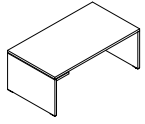
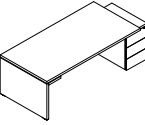
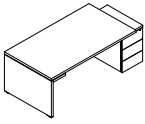
	2000	1000	740	MIT3		97.7	0.274	4		
	1800	1000	740	MIT4		92.7	0.258	4		
	2219	1000	740	MIT3KD		123.7	0.482	4		universal left or right
	2019	1000	740	MIT4KD		118.7	0.465	4		universal left or right

DESK EXTENSION

	1200	600	740	MIT12		32.4	0.085	3		MIT3 and MIT4 - not possible to fix from HPL panel side
--	------	-----	-----	--------------	--	------	-------	---	--	---

DESK PAD

	416	600	5	S100		1.0	0.001	0		eco leather - color black
---	-----	-----	---	-------------	--	-----	-------	---	--	---------------------------

PRODUCT ILLUSTRATION	DIMENSIONS [mm]			INDEX SYMBOL						COMMENTS
	WIDTH	DEPTH	HEIGHT			kg	m3	pcs		

DESKS WITH MANAGERIAL SIDE STORAGE

	2278 2000	2080	740	MIT1		201.1	0.517	11		drawer with lock, universal system left or right
	2078 1800	2080	740	MIT2		196.1	0.501	11		drawer with lock, universal system left or right
	2497 2219	2080	740	MIT1KD		221.1	0.696	11		drawer with lock, universal system left or right
	2297 2019	2080	740	MIT2KD		216.1	0.679	11		drawer with lock, universal system left or right

DESKS WITH ELECTRIC HEIGHT ADJUSTMENT AND MANAGERIAL SIDE STORAGE

	2190	2080	760 1300	MIT1RL		316.9	1.448	14		
	2190	2080	760 1300	MIT1RP		316.9	1.448	14		
	1990	2080	760 1300	MIT2RL		306.4	1.383	14		
	1990	2080	760 1300	MIT2RP		306.4	1.383	14		

ADDITIONAL CHARGE



FEATURE	PRODUCT											COMMENTS
	MIT1	MIT2	MIT1KD	MIT2KD	MIT1RL	MIT1RP	MIT2RL	MIT2RP	kg	m3	pcs	
MEDIAPORT S91E									0.1	0.0001	1	

DESCRIPTION

- NET WEIGHT

VOLUME



NUMBER OF PACKAGES

PRODUCT ILLUSTRATION	DIMENSIONS [mm]			INDEX SYMBOL						COMMENTS
	WIDTH	DEPTH	HEIGHT			kg	m3	pcs		

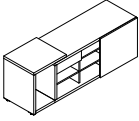
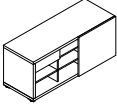

MANAGERIAL STORAGE

	1887	572	690	MIT5		120.4	0.280	8		storage with HPL extension, drawer with lock, sliding door
	1500	572	652	MIT6		98.0	0.233	4		drawer with lock, sliding door

MOBILE PEDESTAL WITHOUT HANDLES WITH HPL TOP AND FRONT

	416	600	587	SLD12HT		23.0	0.158	1		mobile with suspension files drawer, drawers depth - 500mm
	416	600	587	SLD13HT		23.0	0.158	1		drawers depth - 500mm



MOBILE PEDESTAL WITHOUT HANDLES

	428	600	586	MIT120		32.0	0.154	1		
	428	600	586	MIT130		35.0	0.154	1		



PEDESTAL CUSHION



	400	600	52	SKP13		3.0	0.017	1		
---	-----	-----	----	-------	--	-----	-------	---	--	--

ADDITIONAL CHARGE



FEATURE	PRODUCT											COMMENTS
	MIT5	MIT6	SLD12HT	SLD13HT			SKP13		kg	m3	pcs	
MEDIAPORT S91E									0.1	0.0001	1	
II PRICE GROUP									0.9	0.0070	1	
III PRICE GROUP									0.0	0.0000	0	
SELF CLOSING SYSTEM									1.0	0.0010	1	
BALL RUNNERS									1.0	0.0010	1	

DESCRIPTION



 - NET WEIGHT VOLUME NUMBER OF PACKAGES

PRODUCT ILLUSTRATION	DIMENSIONS [mm]			INDEX SYMBOL						COMMENTS
	WIDTH	DEPTH	HEIGHT			kg	m3	pcs		

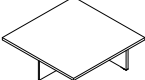
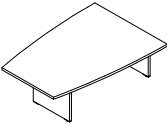
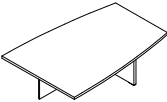
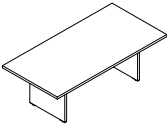

MEETING TABLES



	800	800	740	MIT10		36.0	0.107	3		column ø50mm, disc ø500mm
	1200	1200	740	MIT17		64.0	0.150	3		column ø100mm, disc ø620mm
	1000	600	450	MIT9		33.0	0.091	3		
	1400	1400	740	MIT07		67.4	0.184	4		middle element of conference table - mediaport location A,B,G,H (1pcs) or C,K (2pcs)
	2000	1400 1000	740	MIT06		89.2	0.275	3		begining element of conference table - mediaport location A, B,G,H (1pcs) or C,K (2pcs)
	2000	1400 1000	740	MIT08		77.2	0.252	3		ending element of conference table - mediaport location A,B,G,H (1pcs) or C,K (2pcs)
	2200	1100	740	MIT11		89.0	0.252	2		

ADDITIONAL CHARGE





FEATURE	PRODUCT										COMMENTS
						MIT11		kg	m3	pcs	
MEDIAPORT S91E								0.1	0.0001	1	
MEDIAPORT S92E								0.9	0.0070	1	

DESCRIPTION



 - NET WEIGHT VOLUME NUMBER OF PACKAGES

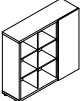
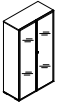
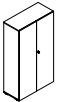
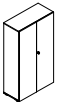
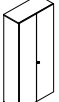

PRODUCT ILLUSTRATION	DIMENSIONS [mm]			INDEX SYMBOL						COMMENTS
	WIDTH	DEPTH	HEIGHT			kg	m3	pcs		

STORAGES

	916	418	879	MIT21		49.0	0.117	1		
	1400	422	879	MIT18		72.0	0.175	3		sliding door
	980	418	1280	MIT22		87.0	0.572	1		file drawers
	1363	418	1280	MIT20		84.0	0.211	2		
	1400	422	1280	MIT7		98.0	0.226	3		sliding door
	916	418	1661	MIT16		81.0	0.265	3		doors with transparent tempered glass and aluminum frame
	916	418	1661	MIT15		80.0	0.229	2		filing cabinet
	916	418	1661	MIT8		69.0	0.151	2		wardrobe/storage cabinet with slide-out hanger
	916	418	2077	MIT19		98.0	0.266	3		filing cabinet

DESCRIPTION

 - NET WEIGHT VOLUME NUMBER OF PACKAGES

PRODUCT ILLUSTRATION	DIMENSIONS [mm]			INDEX SYMBOL						COMMENTS
	WIDTH	DEPTH	HEIGHT			kg	m3	pcs		

ACCESSORIES

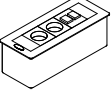
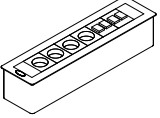
	267	110	93	S91E		1.0	0.010	1		2 x 230V - 2 x RJ45
	426	110	93	S92E		1.0	0.014	1		4 x 230V - 4 x RJ45

DESCRIPTION

 - NET WEIGHT

 VOLUME

 NUMBER OF PACKAGES